



Midea

Make
yourself
at home with

— MIDEA —

H O M E

APPLIANCES

2026 - 2027

CONTENTS

ABOUT MIDEA	02
REFRIGERATOR	03
WASHING MACHINE	26
COOKING RANGE	39
MICROWAVE OVEN	46
DISHWASHER	53
WATER DISPENSER	59
VACUUM CLEANER	66
AIR TREATMENT	72
SMALL APPLIANCES	81
COFFEE MACHINE	90

Welcome to MIDEA

From our humble beginnings in 1968 to becoming a world-leading manufacturer of home appliances, Midea has come a long way.

Driven by innovation and a passion for everyday living, we're committed to delivering surprisingly friendly solutions to enhance moments that matter the most. Today, Midea touches the lives of billions around the world, with products designed for comfort, efficiency, and joy in every home.

1968

He Xiangjian started a business with USD 2,032

1993

Listed on Shenzhen Stock Exchange

2016

Listed in the Fortune Global 500

2025

Listed on HKEX, Became an A-shares and H-shares listed company

1981

"Midea" trademark registered

2007

First overseas manufacturing base built

2023

Sales revenue USD 53.08 billion





*Make room
for life's every
craving*

**REFRIGERATORS
& CHEST FREEZERS**

REFRIGERATOR

WASHING MACHINE

COOKING RANGE

MICROWAVE OVEN

DISHWASHER

WATER DISPENSER

VACUUM CLEANER

AIR TREATMENT

SMALL APPLIANCES

COFFEE MACHINE



MDRM923CIE46M

Our range of refrigerators and freezers is thoughtfully designed to meet every food storage need, right from daily convenience to long-term preservation. Choose from a wide variety of styles, including multi-door, top-mount, and single-door refrigerators, as well as upright and chest freezers — each built for reliable performance, energy efficiency, and smart storage solutions that suit any home.

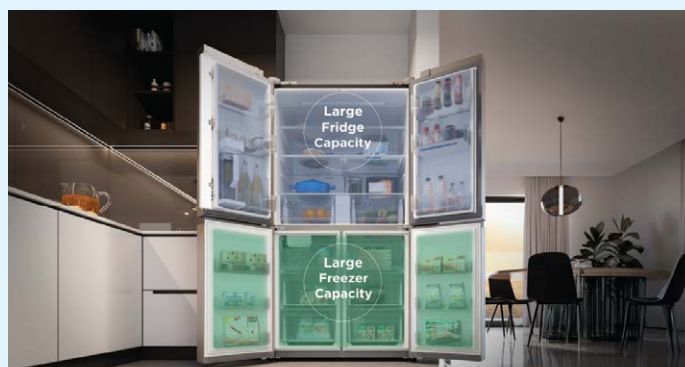

LARGE CAPACITY

Store more in a sleek and stylish way. Get large storage into a modern, counter-depth frame.



INFINITE SHELF

Customize your refrigerator storage with movable shelving that adapts to items tall or small.



AUTOMATIC ICE MAKER

Enjoy a continuous supply of fresh ice with the convenient auto ice maker, eliminating the need for manual trays and ensuring you're always ready to chill your favorite drinks.

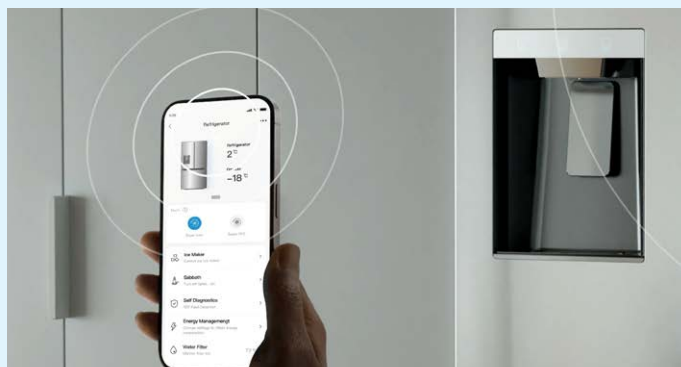

SMART HOME CONNECT

Control the temperature, receive alerts, or activate vacation mode—all from your smartphone.

706L Multi Door MDRM923CIE46M



SPECIFICATION

Capacity: 706 L
Color: Bru Steel
Product Dimension (W×D×H):
 908×736×1775 mm
Net Weight (Kg): 116
Gross Weight (Kg): 126
Market: UAE, Oman, Qatar & Bahrain

KEY FEATURES

INFINITE Shelf
 INFINITE Door Bin
 Built-in Pitcher
 Interactive Door Handle Light
 Platinum Fresh
 Multi-Air Flow
 Flash Cooling
 Vario Zone
 Inverter Quattro
 Auto Ice Maker
 Smart Home Connectivity
 C Energy Efficiency
 Soft LED Light
 Large Volume Capacity



Smart Home
Connectivity



LED
Lamp



Platinum
Fresh



Vario
Zone



Multi-Air
Flow



Inverter
Quattro

641L Multi Door MDRM923CIE46M



SPECIFICATION

Capacity: 641 L
Color: Bru Steel
Product Dimension (W×D×H):
 905×735×1775 mm
Net Weight (Kg): 116
Gross Weight (Kg): 126
Market: Kuwait

KEY FEATURES

INFINITE Shelf
 INFINITE Door Bin
 Built-in Pitcher
 Interactive Door Handle Light
 Platinum Fresh
 Multi-Air Flow
 Flash Cooling
 Vario Zone
 Inverter Quattro
 Auto Ice Maker
 Smart Home Connectivity
 C Energy Efficiency
 Soft LED Light
 Large Volume Capacity



Smart Home
Connectivity



LED
Lamp



Platinum
Fresh



Vario
Zone



Multi-Air
Flow



Inverter
Quattro

474L Multi Door MDRF632FIG46AED



SPECIFICATION

Capacity: 474 L
Color: Bru Steel
Product Dimension (W×D×H):
 833×653×1775 mm
Net Weight (Kg): 85
Gross Weight (Kg): 95
Market: UAE

KEY FEATURES

Smart Sensor
 Platinum Fresh
 Tempered Glass
 Anti-Fall Bins
 Inverter Quattro
 Vario Box
 360° Air Cooling
 Frost Free
 90° Accessible



Platinum
Fresh



Tempered
Glass



Vario
Box



90°
Accessible

424L Multi Door MDRF632FIG46AED



SPECIFICATION

Capacity: 424 L
Color: Bru Steel
Product Dimension (W×D×H):
 833×653×1775 mm
Net Weight (Kg): 85
Gross Weight (Kg): 95
Market: Kuwait

KEY FEATURES

Smart Sensor
 Platinum Fresh
 Tempered Glass
 Anti-Fall Bins
 Inverter Quattro
 Vario Box
 360° Air Cooling
 Frost Free
 90° Accessible



Platinum
Fresh



Tempered
Glass



Vario
Box



90°
Accessible

700L SBS MDRS925CIE46M



SPECIFICATION

Capacity: 700 L
Color: Bru Steel
Product Dimension (W×D×H):
 905×735×1775 mm
Net Weight (Kg): 108
Gross Weight (Kg): 119
Market: UAE, Oman, Qatar & Bahrain

KEY FEATURES

Built-In Pitcher
 Interactive Door Handle Light
 Platinum Fresh
 Multi-Air Flow
 Flash Cooling
 Inverter Quattro
 Auto Ice Maker
 Smart Home Connectivity
 C Energy Efficiency
 Soft LED Light
 Large Volume Capacity



Smart Home
Connectivity



LED
Lamp



Platinum
Fresh



Multi-Air
Flow



Inverter
Quattro

681L SBS MDRS925CIE46M



SPECIFICATION

Capacity: 681 L
Color: Bru Steel
Product Dimension (W×D×H):
 905×735×1775 mm
Net Weight (Kg): 108
Gross Weight (Kg): 119
Market: Kuwait

KEY FEATURES

Built-In Pitcher
 Interactive Door Handle Light
 Platinum Fresh
 Multi-Air Flow
 Flash Cooling
 Inverter Quattro
 Auto Ice Maker
 Smart Home Connectivity
 C Energy Efficiency
 Soft LED Light
 Large Volume Capacity



Smart Home
Connectivity



LED
Lamp



Platinum
Fresh



Multi-Air
Flow



Inverter
Quattro

592L SBS MDRS791MIE46AE



SPECIFICATION

Capacity: 592 L
Color: Bru Steel
Product Dimension (W×D×H):
 910x698x1775 mm
Net Weight (Kg): 86
Gross Weight (Kg): 97
Market: UAE, Oman, Qatar & Bahrain

KEY FEATURES

Inverter Quattro
 Platinum Fresh
 Multi-Air Flow
 Low Noise
 Smart Home Connectivity
 Color Display
 Ultra-Thin Foaming Tech
 90° Accessible
 Humidity Control



Platinum
Fresh



90°
Accessible



Multi-Air
Flow



Low
Noise



Color
Display

555L SBS MDRS710FIE46AED



SPECIFICATION

Capacity: 555 L
Color: Bru Steel
Product Dimension (W×D×H):
 897×706×1765 mm
Net Weight (Kg): 80
Gross Weight (Kg): 90
Market: UAE, Oman, Qatar & Bahrain

KEY FEATURES

Multi-Air Flow
 Digital Control
 Wi-Fi Smart Home
 Big Capacity
 Ice Maker
 Inverter Compressor



Multi-Air
Flow



Digital
Control



Inverter
Compressor



Wi-Fi Smart
Home



Ice
Maker

553L SBS MDRS704FIE02AE



SPECIFICATION

Capacity: 553 L
Color: Stainless Steel
Product Dimension (W×D×H):
 897×706×1765 mm
Net Weight (Kg): 80
Gross Weight (Kg): 90
Market: UAE, Oman, Qatar & Bahrain

KEY FEATURES

Wi-Fi Smart Home
 Big Capacity
 Twist Ice Tray
 Water Dispenser
 Multi-Air Flow
 Digital Control
 Inverter Compressor



Multi-Air
Flow



Digital
Control



Inverter
Compressor



Wi-Fi Smart
Home

513L SBS MDRS791MIE46AE



SPECIFICATION

Capacity: 513 L
Color: Bru Steel
Product Dimension (W×D×H):
 910×698×1775 mm
Net Weight (Kg): 86
Gross Weight (Kg): 97
Market: Kuwait

KEY FEATURES

Inverter Quattro
 Platinum Fresh
 Multi-Air Flow
 Low Noise
 Smart Home
 Color Display
 Ultra-thin Foaming Tech
 90° Accessible
 Humidity Control



Platinum
Fresh



90°
Accessible



Multi-Air
Flow



Low
Noise



Color
Display

513L SBS MDRS704FIE02AE



SPECIFICATION

Capacity: 513 L
Color: Stainless Steel
Product Dimension (W×D×H):
 897×706×1765 mm
Net Weight (Kg): 80
Gross Weight (Kg): 90
Market: Kuwait

KEY FEATURES

Wi-Fi Smart Home
 Big Capacity
 Twist Ice Tray
 Water Dispenser
 Multi-Air Flow
 Digital Control
 Inverter Compressor



Multi-Air
Flow



Digital
Control



Inverter
Compressor



Wi-Fi Smart
Home

510L SBS MDRS710FIE46AED



SPECIFICATION

Capacity: 510 L
Color: Bru Steel
Product Dimension (W×D×H):
 897×706×1765 mm
Net Weight (Kg): 80
Gross Weight (Kg): 90
Market: Kuwait

KEY FEATURES

Multi-Air Flow
 Digital Control
 Wi-Fi Smart Home
 Big Capacity
 Ice Maker
 Inverter Compressor



Multi-Air
Flow



Digital
Control



Inverter
Compressor



Wi-Fi Smart
Home



Ice
Maker

651L TMF MDRT866FGE46AE



SPECIFICATION

Capacity: 651 L
Color: Bru Steel
Product Dimension (W×D×H):
 834×820×1860 mm
Net Weight (Kg): 100.3
Gross Weight (Kg): 111.8
Market: Kuwait

KEY FEATURES

Large Capacity with
 Multi-Storage Space
 Digital Display
 Inverter Quattro
 Double Humidity-
 Control Crisper
 Chill Case
 Removable Ice Maker
 2-in-1 Egg Tray



Large
 Capacity



Digital
 Control



2-in-1
 Egg Tray

650L TMF MDRT866FGE46AE



SPECIFICATION

Capacity: 650 L
Color: Bru Steel
Product Dimension (W×D×H):
 834×820×1860 mm
Net Weight (Kg): 100.3
Gross Weight (Kg): 111.8
Market: UAE, Oman, Qatar & Bahrain

KEY FEATURES

Large Capacity with
 Multi-Storage Space
 Digital Display
 Inverter Quattro
 Double Humidity-
 Control Crisper
 Chill Case
 Removable Ice Maker
 2-in-1 Egg Tray



Large
 Capacity



Digital
 Control



2-in-1
 Egg Tray

535L TMF MDRT723MTE46AED



SPECIFICATION

Capacity: 535 L
Color: Bru Steel
Product Dimension (W×D×H):
 750×738×1822 mm
Net Weight (Kg): 79
Gross Weight (Kg): 87
Market: UAE, Oman, Qatar & Bahrain

KEY FEATURES

Smart Cooling
 Active-C Fresh
 Humidity Control
 Large Capacity with
 Multi-Storage Space
 Chill Case
 Removable Ice Maker
 2-in-1 Egg Tray
 Digital Display
 Inverter Quattro
 Double Humidity Control Crisper



Large
 Capacity



Digital
 Control



2-in-1
 Egg Tray



Humidity
 Control



Smart
 Cooling



Active-C
 Fresh

471L TMF MDRT650MME46DO



SPECIFICATION

Capacity: 471 L
Color: Bru Steel
Product Dimension (W×D×H):
 700×688×1850 mm
Net Weight (Kg): 68
Gross Weight (Kg): 76
Market: UAE, Bahrain, Oman & Qatar

KEY FEATURES

Extra Freezer (-10°C, -4°C, 2°C)
 Inverter Quattro
 Total No Frost
 Lumi Button Panel
 Super Freeze
 Max Cube
 Extra Cold
 Extra Freezer Space
 2L Bottle Rack



Inverter
Quattro



2L Bottle
Rack



Super
Freeze

467L TMF MDRT650MME46DO



SPECIFICATION

Capacity: 467 L
Color: Bru Steel
Product Dimension (W×D×H):
 700×688×1850 mm
Net Weight (Kg): 68
Gross Weight (Kg): 76
Market: Kuwait

KEY FEATURES

Extra Freezer (-10°C, -4°C, 2°C)
 Inverter Quattro
 Total No Frost
 Lumi Button Panel
 Super Freeze
 Max Cube
 Extra Cold
 Extra Freezer Space
 2L Bottle Rack



Inverter
Quattro



2L Bottle
Rack



Super
Freeze

463L TMF MDRT645MTE46AED



SPECIFICATION

Capacity: 463L
Color: Bru Steel
Product Dimension (W×D×H):
 700×691×1880 mm
Net Weight (Kg): 71
Gross Weight (Kg): 78
Market: UAE, Oman, Qatar, Bahrain
 & Kuwait

KEY FEATURES

Frost Free
 Multi-Air Flow
 Electronic Control
 Humidity Control
 Smart Cooling
 Active-C Fresh
 Cooling Box



Smart
Cooling



Active-C
Fresh



Frost
Free



Humidity
Control



True Big
Capacity

454L TMF MDRT611MME46DO



SPECIFICATION

Capacity: 454 L
Color: Bru Steel
Product Dimension (W×D×H):
 700x688x1725 mm
Net Weight (Kg): 62
Gross Weight (Kg): 70
Market: UAE, Bahrain, Oman & Qatar

KEY FEATURES

Inverter Quattro
 Total No Frost
 Lumi Button Panel
 Super Freeze
 Max Cube
 Extra Cold
 2L Bottle Rack



Inverter
Quattro



2L Bottle
Rack



Super
Freeze

454L TMF MDRT611MME50DO



SPECIFICATION

Capacity: 454 L
Color: Crystal Silver
Product Dimension (W×D×H):
 700x688x1725 mm
Net Weight (Kg): 62
Gross Weight (Kg): 70
Market: UAE, Bahrain, Oman & Qatar

KEY FEATURES

Inverter Quattro
 Total No Frost
 Lumi Button Panel
 Super Freeze
 Max Cube
 Extra Cold
 2L Bottle Rack



Inverter
Quattro



2L Bottle
Rack



Super
Freeze

450L TMF MDRT611MME50DO



SPECIFICATION

Capacity: 450 L
Color: Crystal Silver
Product Dimension (W×D×H):
 700x688x1725 mm
Net Weight (Kg): 62
Gross Weight (Kg): 70
Market: Kuwait

KEY FEATURES

Inverter Quattro
 Total No Frost
 Lumi Button Panel
 Super Freeze
 Max Cube
 Extra Cold
 2L Bottle Rack



Inverter
Quattro



2L Bottle
Rack



Super
Freeze

450L TMF MDRT611MME46DO



SPECIFICATION

Capacity: 450 L
Color: Bru Steel
Product Dimension (W×D×H):
 700×688×1725 mm
Net Weight (Kg): 62
Gross Weight (Kg): 70
Market: Kuwait

KEY FEATURES

Inverter Quattro
 Total No Frost
 Lumi Button Panel
 Super Freeze
 Max Cube
 Extra Cold
 2L Bottle Rack



Inverter
Quattro



2L Bottle
Rack



Super
Freeze

413L TMF MDRT580MTE46AED



SPECIFICATION

Capacity: 413 L
Color: Bru Steel
Product Dimension (W×D×H):
 700×691×1723 mm
Net Weight (Kg): 65
Gross Weight (Kg): 71
Market: UAE, Oman, Qatar & Bahrain

KEY FEATURES

Frost Free
 Multi-Air Flow
 Electronic Control
 Humidity Control
 Smart Cooling
 Active-C Fresh
 Cooling Box



Smart
Cooling



Active-C
Fresh



Frost
Free



Humidity
Control



True Big
Capacity

411L TMF MDRT580MTE46AED



SPECIFICATION

Capacity: 411 L
Color: Bru Steel
Product Dimension (W×D×H):
 700×691×1723 mm
Net Weight (Kg): 65
Gross Weight (Kg): 71
Market: Kuwait

KEY FEATURES

Frost Free
 Multi-Air Flow
 Electronic Control
 Humidity Control
 Smart Cooling
 Active-C Fresh
 Cooling Box



Smart
Cooling



Active-C
Fresh



Frost
Free



Humidity
Control



True Big
Capacity

379L TMF MDRT533MME50D



SPECIFICATION

Capacity: 379 L
Color: Crystal Silver
Product Dimension (W×D×H):
 595x679x1721 mm
Net Weight (Kg): 53,5
Gross Weight (Kg): 60
Market: UAE, Bahrain, Oman & Qatar

KEY FEATURES

Inverter Quattro
 Total No Frost
 Lumi Button Panel
 Super Freeze
 Max Cube
 Extra Cold
 2L Bottle Rack



Inverter
Quattro



2L Bottle
Rack



Frost
Free

376L TMF MDRT533MME50D



SPECIFICATION

Capacity: 376 L
Color: Crystal Silver
Product Dimension (W×D×H):
 595x679x1721 mm
Net Weight (Kg): 53,5
Gross Weight (Kg): 60
Market: Kuwait

KEY FEATURES

Inverter Quattro
 Total No Frost
 Lumi Button Panel
 Super Freeze
 Max Cube
 Extra Cold
 2L Bottle Rack



Inverter
Quattro



2L Bottle
Rack



Frost
Free

338L TMF MDRT495MTE46AE



SPECIFICATION

Capacity: 338 L
Color: Bru Steel
Product Dimension (W×D×H):
 595x695x1724 mm
Net Weight (Kg): 55
Gross Weight (Kg): 62
Market: UAE

KEY FEATURES

Smart Sensors
 Multi-Air Flow
 Active C Fresh
 Humidity Control
 Electronic Control
 Removable Ice Maker
 2-in-1 Egg tray
 Cooling Tray
 2L Bottle Bin
 LED



Smart
Cooling



Active-C
Fresh



Frost
Free



Humidity
Control



True Big
Capacity



Multi-Air
Flow

338L TMF MDRT489MTE46AE



SPECIFICATION

Capacity: 338 L
Color: Bru Steel
Product Dimension (W×D×H):
 595×695×1724 mm
Net Weight (Kg): 55
Gross Weight (Kg): 62
Market: UAE, Bahrain, Oman,
 Qatar & Kuwait

KEY FEATURES

Frost Free
 Multi-Air Flow
 Electronic Control
 Humidity Control
 Smart Cooling
 Active-C Fresh
 Cooling Box



Smart
Cooling



Active-C
Fresh



Frost
Free



Humidity
Control



True Big
Capacity

266L TMF MDRT385MTE46AE



SPECIFICATION

Capacity: 266 L
Color: Bru Steel
Product Dimension (W×D×H):
 545×610×1657 mm
Net Weight (Kg): 45
Gross Weight (Kg): 49
Market: UAE, Bahrain, Oman & Qatar

KEY FEATURES

2L Bottle Rack
 Frost Free
 Multi-Air Flow
 Cooling Box
 LED Lamp
 Adjustable Shelves
 Big Cooling Box



Adjustable
Shelves



LED
Lamp



2L Bottle
Rack



Multi-Air
Flow

262L TMF MDRT385MTE46AE



SPECIFICATION

Capacity: 262 L
Color: Bru Steel
Product Dimension (W×D×H):
 545×610×1657 mm
Net Weight (Kg): 45
Gross Weight (Kg): 49
Market: Kuwait

KEY FEATURES

2L Bottle Rack
 Frost Free
 Multi-Air Flow
 Cooling Box
 LED Lamp
 Adjustable Shelves
 Big Cooling Box



Adjustable
Shelves



LED
Lamp



2L Bottle
Rack



Multi-Air
Flow

266L TMF MDRT395MTE46AE



SPECIFICATION

Capacity: 266 L
Color: Bru Steel
Product Dimension (W×D×H):
 545×610×1657 mm
Net Weight (Kg): 45
Gross Weight (Kg): 49
Market: UAE

KEY FEATURES

Inverter Quattro
 Smart Sensors
 Multi-Air Flow
 Active C Fresh
 Humidity Control
 Electronic Control
 Removable Ice Maker
 2-in-1 Egg tray
 Cooling Tray
 2L Bottle Rack



Multi-Air
Flow



LED
Lamp



2L Bottle
Rack



Active-C
Fresh

266L TMF MDRT390MTE28AE



SPECIFICATION

Capacity: 266 L
Color: Jazz Black
Product Dimension (W×D×H):
 545×610×1657 mm
Net Weight (Kg): 45
Gross Weight (Kg): 49
Market: UAE

KEY FEATURES

Inverter Quattro
 Smart Sensors
 Multi-Air Flow
 Active C Fresh
 Humidity Control
 Electronic Control
 Removable Ice Maker
 2-in-1 Egg tray
 Cooling Tray
 2L Bottle Rack



Adjustable
Shelves



LED
Lamp



2L Bottle
Rack



Multi-Air
Flow

236L TMF MDRT346MTE46AED



SPECIFICATION

Capacity: 236 L
Color: Bru Steel
Product Dimension (W×D×H):
 545×610×1522 mm
Net Weight (Kg): 43
Gross Weight (Kg): 47
Market: UAE, Oman & Qatar

KEY FEATURES

2L Bottle Bin
 Electronic Control
 Inverter Quattro
 Active-C Fresh
 Crisper
 Fruit & Vegetable Crisper



2L Bottle
Rack



Active-C
Fresh



2-in-1
Egg Tray

87L TMF MDRT134FGE01AE



SPECIFICATION

Capacity: 87 L
Color: White
Product Dimension (W×D×H):
 470×492×837 mm
Net Weight (Kg): 21.6
Gross Weight (Kg): 24.1
Market: UAE + GCC

KEY FEATURES

Manual Defrost
 Mechanical Control
 Recessed Handle
 2L Bottle Bin
 LED Lamp
 Noise 40 dB
 Fruit & Vegetable Crisper



2L
Bottle
Rack



LED
Lamp



Low
Noise

680L BMF MDRB905FGL46D



SPECIFICATION

Capacity: 680 L
Color: Bru Steel
Product Dimension (W×D×H):
 830×715×1845 mm
Net Weight (Kg): 94
Gross Weight (Kg): 104
Market: UAE + GCC

KEY FEATURES

Megamax Technology
 INFINITE Shelf
 INFINITE Door Bin
 Lumi Button
 Smart Home
 Smart Sense Light
 Platinum Fresh
 Inverter Quattro
 Cooling Zone



Smart Home
Connectivity



Inverter
Quattro



Cooling
Zone

190L Single Door MDRD268FEE50AE



SPECIFICATION

Capacity: 190 L
Color: Silver
Product Dimension (W×D×H):
 520×540×1246 mm
Net Weight (Kg): 32
Gross Weight (Kg): 35
Market: UAE, Bahrain, Oman & Kuwait

KEY FEATURES

Cooling Zone
 Electronic Control
 LED Lamp
 Adjustable Shelves
 Adjustable Legs



Adjustable
Shelves



LED
Lamp



Adjustable
Leg



Cooling
Zone

93L Single Door MDRD142SLE01AE



SPECIFICATION

Capacity: 93 L
Color: White
Product Dimension (W×D×H):
 488×440×841 mm
Net Weight (Kg): 20.2
Gross Weight (Kg): 22.6
Market: UAE + GCC

KEY FEATURES

Retro Design
 Chiller Box
 Adjustable Shelf
 Temperature Control
 Adjustable Legs



Chiller Box



Temperature Control



Adjustable Shelves

93L Single Door MDRW150FGG22AE



SPECIFICATION

Capacity: 93 L
Color: Black Glass
Product Dimension (W×D×H):
 470×440×845 mm
Net Weight (Kg): 26.5
Gross Weight (Kg): 29
Market: UAE + GCC

KEY FEATURES

Mechanical Control
 Recessed Handle
 Adjustable Legs
 Glass Door With Lamp (2W)
 Noise 40 dB



Mechanical Control



Adjustable Leg



Noise 40 dB

65L Single Door MDRD108FGE01



SPECIFICATION

Capacity: 65 L
Color: White
Product Dimension (W×D×H):
 445×510×630 mm
Net Weight (Kg): 16.4
Gross Weight (Kg): 17.9
Market: Kuwait

KEY FEATURES

Sealed Box
 Reversible Door
 2L Bottle in-door Storage
 Stylish and Practical Design
 More Storage with Less Effort



Reversible Door



2L Bottle In-Door Storage



More Storage with Less Effort

43L Single Door MDRD86FGE01AE



SPECIFICATION

Capacity: 43 L
Color: White
Product Dimension (W×D×H):
 472×450×492 mm
Net Weight (Kg): 13.2
Gross Weight (Kg): 14.6
Market: UAE + GCC

KEY FEATURES

Sealed Box
 Reversible Door
 2L Bottle in-door Storage
 Stylish and Practical Design
 More Storage with Less Effort



Reversible
Door



2L Bottle
In-Door Storage



More Storage
with Less Effort

416L MDRZ562FGG21



SPECIFICATION

Capacity: 416 L
Color: White
Product Dimension (W×D×H):
 690×695×2185 mm
Net Weight (Kg): 92
Gross Weight (Kg): 101
Market: Kuwait

KEY FEATURES

Large Display Capacity
 Glass Door Design
 Adjustable Legs
 High-Temperature Alarm
 Rolling Wheels
 Single-Door Format
 Commercial Reliability



Large Display
Capacity



High
Temperature
Alarm



Glass Door
Design

309L SC HS-411S



SPECIFICATION

Capacity: 309 L
Color: White
Product Dimension (W×D×H):
 610×595×2005 mm
Net Weight (Kg): 72
Gross Weight (Kg): 80
Market: UAE + GCC

KEY FEATURES

Double-Layer Tempered Glass
 Low-E Glass
 HIPS Interior
 Adjustable Shelves
 360°C Cooling



Adjustable
Shelves



Double-Layer
Tempered Glass



360°C
Cooling

265L SC HS-411S



SPECIFICATION

Capacity: 265 L
Color: White
Product Dimension (W×D×H):
 610×595×2005 mm
Net Weight (Kg): 72
Gross Weight (Kg): 80
Market: Kuwait

KEY FEATURES

Double-Layer Tempered Glass
 Low-E Glass
 HIPS Interior
 Adjustable Shelves
 360°C Cooling



Adjustable
Shelves



Double-Layer
Tempered Glass



360°C
Cooling

211L SC HS-281S



SPECIFICATION

Capacity: 211 L
Color: White
Product Dimension (W×D×H):
 610×520×1747 mm
Net Weight (Kg): 58
Gross Weight (Kg): 64
Market: Kuwait

KEY FEATURES

Double-Layer Tempered Glass
 Low-E Glass
 HIPS Interior
 Adjustable Shelves
 360°C Cooling



Adjustable
Shelves



Double-Layer
Tempered Glass



360°C
Cooling

594L UF MDRU793FGE46LAE



SPECIFICATION

Capacity: 594 L
Color: Bru Steel
Product Dimension (W×D×H):
 832×735×1950 mm
Net Weight (Kg): 97.8
Gross Weight (Kg): 109.8
Market: Kuwait, Bahrain & Qatar

KEY FEATURES

Convertible Freezer to Fridge
 Garage Ready
 Frost Free
 Grip Handle
 Digital Control
 Adjustable Legs
 Easy-Roll Castors



Grip
Handle



Easy-Roll
Castors



Frost
Free



Digital
Control

594L UF MDRU793FGE46RAE



SPECIFICATION

Capacity: 594 L
Color: Bru Steel
Product Dimension (W×D×H):
 832×735×1950 mm
Net Weight (Kg): 97.8
Gross Weight (Kg): 109.8
Market: Kuwait, Bahrain & Qatar

KEY FEATURES

Convertible Freezer to Fridge
 Garage Ready
 Frost Free
 Grip Handle
 Digital Control
 Adjustable Legs
 Easy-Roll Castors



Grip Handle



Easy-Roll Castors



Frost Free



Digital Control

474L UF MDRD502FEE46AE



SPECIFICATION

Capacity: 474 L
Color: Bru Steel
Product Dimension (W×D×H):
 595×618×1850 mm
Net Weight (Kg): 57.5
Gross Weight (Kg): 64
Market: UAE + GCC

KEY FEATURES

Frost Free
 Convertible Freezer to Fridge
 Digital Control
 Multi-Air Flow
 Reversible Door
 Adjustable Shelves
 LED Light
 Grip Handle



Grip Handle



LED Lamp



Frost Free



Digital Control

424L UF MDRD502FEE46AE



SPECIFICATION

Capacity: 424 L
Color: Bru Steel
Product Dimension (W×D×H):
 595×618×1850 mm
Net Weight (Kg): 57.5
Gross Weight (Kg): 64
Market: Kuwait

KEY FEATURES

Frost Free
 Convertible Freezer to Fridge
 Digital Control
 Multi-Air Flow
 Reversible Door
 Adjustable Glass Shelves
 LED Light
 Grip Handle



Grip Handle



LED Lamp



Frost Free



Digital Control

272L UF MDRU385FEE46AE



SPECIFICATION

Capacity: 272 L
Color: Bru Steel
Product Dimension (W×D×H):
 595×635×1850 mm
Net Weight (Kg): 66
Gross Weight (Kg): 73
Market: UAE + GCC

KEY FEATURES

Electronic Control
 Convertible Freezer to Fridge
 8 Storage Compartments
 Reversible Door
 Fast Freeze Function
 LED Light
 Frost Free



LED Lamp



Super Cool Function



Frost Free

257L UF MDRU385FEE46AE



SPECIFICATION

Capacity: 257 L
Color: Bru Steel
Product Dimension (W×D×H):
 595×635×1850 mm
Net Weight (Kg): 66
Gross Weight (Kg): 73
Market: Kuwait

KEY FEATURES

Electronic Control
 Convertible Freezer to Fridge
 8 Storage Compartments
 Reversible Door
 Fast Freeze Function
 LED Light
 Frost Free



LED Lamp



Super Cool Function



Frost Free

238L UF MDRU333FEE46AE



SPECIFICATION

Capacity: 238 L
Color: Bru Steel
Product Dimension (W×D×H):
 595×635×1850 mm
Net Weight (Kg): 66
Gross Weight (Kg): 73
Market: UAE + Bahrain

KEY FEATURES

Electronic Control
 Convertible Freezer to Fridge
 8 Storage Compartments
 Reversible Door
 Fast Freeze Function
 LED Light
 Frost Free



LED Lamp



Super Cool Function



Frost Free

227L UF MDRU333FEE46AE



SPECIFICATION

Capacity: 227 L
Color: Bru Steel
Product Dimension (W×D×H):
595×635×1850 mm
Net Weight (Kg): 66
Gross Weight (Kg): 73
Market: Kuwait

KEY FEATURES

Electronic Control
Convertible Freezer to Fridge
8 Storage Compartments
Reversible Door
Fast Freeze Function
LED Light
Frost Free



LED
Lamp



Super Cool
Function



Frost
Free

508L Chest Freezer MDRC698FZE01AE



SPECIFICATION

Capacity: 508L / 17.94 Cu. Ft
Product Dimension (W×D×H):
 1530×735×830 mm
Package Dimension (W×D×H):
 1565×776×870 mm
Net Weight (Kg): 60.3
Gross Weight (Kg): 67.1
Rated Power (W): 260
Market: UAE + GCC

KEY FEATURES

Inverter Compressor
 Adjustable Thermostat
 Easy to Clean Interior
 Hovering Door
 Convenient Drain Tube
 Grip Handle
 Lock & Key
 LED Lights
 Removable Storage Baskets
 Easy Rolling Wheels
 Manual Defrost



Easy Rolling
Wheels



Removable
Storage Basket



Lock

418L Chest Freezer MDRC565FZE01D



SPECIFICATION

Capacity: 418 L
Product Dimension (W×D×H):
 1416×750×825 mm
Package Dimension (W×D×H):
 1449×778×885 mm
Net Weight (Kg): 62.3
Gross Weight (Kg): 68.8
Rated Power (W): 200
Market: UAE, Bahrain, Oman,
 Qatar & Kuwait

KEY FEATURES

Faster Freezing
 Inverter Quattro
 Deep Freeze -30°C
 Multi-Angle Hover Door
 Outage Memory
 Eco-Friendly Basket
 D+ Quick-Freezing System
 Multiple Temperature
 True Big Capacity



Faster
Freezing



Inverter
Quattro



Deep Freeze
-30°C



Eco-Friendly
Basket

293L Chest Freezer MDRC411FZE01D



SPECIFICATION

Capacity: 293 L
Product Dimension (W×D×H):
 1065×592×844 mm
Package Dimension (W×D×H):
 1104×613×888 mm
Net Weight (Kg): 36
Gross Weight (Kg): 40.5
Rated Power (W): 200
Market: UAE, Bahrain, Oman,
 Qatar & Kuwait

KEY FEATURES

Faster Freezing
 Inverter Quattro
 Deep Freeze -30°C
 Multi-Angle Hover Door
 Outage Memory
 Eco-Friendly Basket
 D+ Quick-Freezing System
 Multiple Temperature
 True Big Capacity



Faster
Freezing



Inverter
Quattro



Deep Freeze
-30°C



Eco-Friendly
Basket

249L Chest Freezer MDRC345FZE01AE



SPECIFICATION

Capacity: 249 L
Product Dimension (W×D×H):
 985×600×850 mm
Package Dimension (W×D×H):
 1025×625×885 mm
Net Weight (Kg): 37.4
Gross Weight (Kg): 41.4
Market: UAE, Bahrain & Oman

KEY FEATURES

Faster Freezing
 Inverter Quattro
 Deep Freeze -30°C
 Multi-Angle Hover Door
 Outage Memory
 Eco-Friendly Basket
 D+ Quick-Freezing System
 Multiple Temperature
 True Big Capacity



Faster Freezing



Inverter Quattro



Deep Freeze -30°C



Eco-Friendly Basket

198L Chest Freezer MDRC284FZE01D



SPECIFICATION

Capacity: 198 L
Product Dimension (W×D×H):
 770×560×850 mm
Package Dimension (W×D×H):
 797×578×888 mm
Net Weight (Kg): 28.2
Gross Weight (Kg): 31.2
Rated Power (W): 70
Market: UAE, Bahrain, Oman, Qatar & Kuwait

KEY FEATURES

Faster Freezing
 Inverter Quattro
 Deep Freeze -30°C
 Multi-Angle Hover Door
 Outage Memory
 Eco-Friendly Basket
 D+ Quick-Freezing System
 Multiple Temperature
 True Big Capacity



Faster Freezing



Inverter Quattro



Deep Freeze -30°C



Eco-Friendly Basket

143L Chest Freezer MDRC211FZE01D



SPECIFICATION

Capacity: 143 L
Product Dimension (W×D×H):
 600×560×850 mm
Package Dimension (W×D×H):
 629×578×888 mm
Net Weight (Kg): 24.7
Gross Weight (Kg): 27.2
Rated Power (W): 70
Market: UAE, Bahrain, Oman, Qatar & Kuwait

KEY FEATURES

Faster Freezing
 Inverter Quattro
 Deep Freeze -30°C
 Multi-Angle Hover Door
 Outage Memory
 Eco-Friendly Basket
 D+ Quick-Freezing System
 Multiple Temperature
 True Big Capacity



Faster Freezing



Inverter Quattro



Deep Freeze -30°C



Eco-Friendly Basket

99L Chest Freezer
MDRC154FZE01D



SPECIFICATION

Capacity: 99 L
Product Dimension (W×D×H):
 547x446x850 mm
Package Dimension (W×D×H):
 574x463x888 mm
Net Weight (Kg): 19.7
Gross Weight (Kg): 22.1
Rated Power (W): 70
Market: UAE, Bahrain, Oman, Qatar
 & Kuwait

KEY FEATURES

Faster Freezing
 Inverter Quattro
 Deep Freeze -30C
 Multi-Angle Hover Door
 Outage Memory
 Eco-Friendly Basket
 D+ Quick-Freezing System
 Multiple Temperature
 True Big Capacity



Faster Freezing



Inverter Quattro



Deep Freeze -30°C



Eco-Friendly Basket





*Make room
for more life*

**WASHING
MACHINES**



MF210W100WB

Discover the freshest, most efficient and convenient way to do your laundry. Browse through the best front load, top load and twin tub washing machines to find a washing partner you can rely on.



535MM INNOVATIVE LARGE DRUM

Large porthole for easier loading and unloading, and innovative inner drum design with Sapphire Drum and Whale Fin Paddles for stronger water flow.



HEALTH GUARD 99.99% SANITIZATION

Powerful steam penetrates deep into fibres to remove tough stains and eliminate 99.99%* of bacteria, ensuring deeper cleaning and enhanced hygiene.



TURBO FOAM WASH

30% faster clean, no compromise on performance.



SMART CONTROL

Start cycles, monitor progress and get completion notifications remotely with MSmartHome.

10KG Front Load
MF210W100WB



SPECIFICATION

Capacity: 10 KG
Spin Capacity: 10 KG
Number of Program: 14
Color: White / Titanium
Max Spin Speed: 1400 RPM
Product Dimension (WxDxH):
 595x580x850 mm
Package Dimension (WxDxH):
 680x665x885 mm
Net Weight (Kg): 68
Gross Weight (Kg): 73
Rated Power: 1900W
Market: UAE, Qatar, Oman & Kuwait

KEY FEATURES

Smart Control
 Quick Wash 15
 Child Lock
 Health Guard 99.99% Sanitization
 Drum Clean
 Extra Rinse
 Steam Care
 533mm Larger Inner Drum
 PowerMix



Child Lock



Door Lock



Drum Clean



Hygiene 90°C



Quick Wash 15

21KG Front Load
MF600W210B



SPECIFICATION

Capacity: 21 KG
Spin Capacity: 21 KG
Number of Program: 14
Color: Silver
Max Spin Speed: 1300 RPM
Product Dimension (WxDxH):
 686x864x1010 mm
Package Dimension (WxDxH):
 920x760x1100 mm
Net Weight (Kg): 109
Gross Weight (Kg): 119
Rated Power: 1950W
Market: UAE, Kuwait, Qatar & Oman

KEY FEATURES

Door Lock
 Hygiene 90°C
 Child Lock
 Extra Rinse
 Temperature Selection
 Easy Laundry
 Effectively Eliminates Bacteria
 Less Noise
 Steam
 Drum Clean



Door Lock



Hygiene 90°C



Steam Care



Child Lock



Drum Clean



Extra Rinse

12KG Front Load
MF200W120WB



SPECIFICATION

Capacity: 12 KG
Spin Capacity: 12 KG
Number of Program: 14
Color: White / Titanium
Max Spin Speed: 1400 RPM
Product Dimension (WxDxH):
 595x595x850 mm
Package Dimension (WxDxH):
 680x725x875 mm
Net Weight (Kg): 72
Gross Weight (Kg): 76
Rated Power: 2000W
Market: UAE, Kuwait, Oman & Qatar

KEY FEATURES

Door Lock
 Extra Rinse
 Temperature Selection
 Health Guard
 Steam Care
 Smart Control
 Health Guard
 Lunar Dial
 Quick Wash 15 / 45
 Child Lock
 Drum Clean



Wi-Fi



Wide Door



Steam Care



Child Lock



Drum Clean



Extra Rinse

11.5KG Front Load
MF205W115WB



SPECIFICATION

Capacity: 11.5 KG
Spin Capacity: 11.5 KG
Number of Program: 15
Color: Titanium
Product Dimension (W×D×H):
 595x575x850 mm
Package Dimension (W×D×H):
 695x680x885 mm
Net Weight (Kg): 68
Gross Weight (Kg): 73
Rated Power: 1900W
Market: UAE

KEY FEATURES

Health Guard
 Quick 45'/15'
 Perfume+
 WiFi
 Turbo
 Steam
 PowerGuard
 Child Lock



Child Lock



Wi-Fi



Super Soft
Close Lid



PowerGuard

10KG Front Load
MF205W100WB



SPECIFICATION

Capacity: 10 KG
Spin Capacity: 10 KG
Number of Program: 15
Color: Titanium
Product Dimension (W×D×H):
 595x555x850 mm
Package Dimension (W×D×H):
 680x660x885 mm
Net Weight (Kg): 67
Gross Weight (Kg): 71
Rated Power: 1880W
Market: UAE, Qatar, Bahrain,
 Oman & Kuwait

KEY FEATURES

Health Guard
 Quick 45'/15'
 Perfume+
 WiFi
 Turbo
 Steam
 PowerGuard
 Child Lock



Child Lock



Wi-Fi



Super Soft
Close Lid



PowerGuard

10KG Front Load
MF200W100WB



SPECIFICATION

Capacity: 10 KG
Spin Capacity: 10 KG
Number of Program: 14
Color: Titanium / White
Max Spin Speed: 1400 RPM
Product Dimension (W×D×H):
 535x595x850 mm
Package Dimension (W×D×H):
 680x660x875 mm
Net Weight (Kg): 65
Gross Weight (Kg): 69
Rated Power: 2000W
Market: UAE, Qatar

KEY FEATURES

Door Lock
 Extra Rinse
 Temperature Selection
 Health Guard
 Wi-Fi
 Quick Wash 15
 Lunar Dial
 Steam Care
 Drum Clean
 Child Lock



Wi-Fi



Child Lock



Drum Clean



Wide Door



Extra Rinse



Steam Care

9KG Front Load
MF110W90B



SPECIFICATION

Capacity: 9 KG
Spin Capacity: 9 KG
Number of Program: 15
Color: Titanium
Product Dimension (W×D×H):
 595x535x850 mm
Package Dimension (W×D×H):
 680x660x885 mm
Net Weight (Kg): 61
Gross Weight (Kg): 66
Rated Power: 1950W
Market: UAE

KEY FEATURES

Turbo
 Health Guard
 Drum Clean
 Quick Wash 15 / 45
 PowerMix
 BLDC Inverter Motor



Turbo



Drum Clean



Quick Wash 15



BLDC Inverter Motor

8KG Front Load
MF110W80B



SPECIFICATION

Capacity: 8 KG
Spin Capacity: 8 KG
Number of Program: 15
Color: White / Titanium
Max Spin Speed: 1400 RPM
Product Dimension (W×D×H):
 595x535x850 mm
Package Dimension (W×D×H):
 655x560x885 mm
Net Weight (Kg): 60
Gross Weight (Kg): 63
Rated Power: 1950W
Market: UAE, Qatar, Bahrain, Kuwait & Oman

KEY FEATURES

Turbo
 Health Guard
 Drum Clean
 Quick Wash 15 / 45
 PowerMix
 BLDC Inverter Motor



Drum Clean



BLDC Inverter Motor



Quick Wash 15



Turbo

7KG Front Load
MF110W70B



SPECIFICATION

Capacity: 7 KG
Spin Capacity: 7 KG
Number of Program: 15
Color: White / Titanium
Max Spin Speed: 1200 RPM
Product Dimension (W×D×H):
 595x465x850 mm
Package Dimension (W×D×H):
 655x500x885 mm
Net Weight (Kg): 57
Gross Weight (Kg): 61
Rated Power: 2050W
Market: UAE, Oman & Kuwait

KEY FEATURES

Easy Control
 Quick Wash 15
 Rapid Dissolution
 Steam Sanitization
 Inverter Motor
 Extra Rinse
 Child Lock
 Turbo
 Health Guard
 Drum Clean
 PowerMix
 BLDC Inverter Motor



Child Lock



Quick Wash 15



BLDC Inverter Motor



Drum Clean



Turbo

7KG Front Load
MF100W70



SPECIFICATION

Capacity: 7 KG
Drying Capacity: 7 KG
Number of Program: 15
Color: White / Titanium
Max Spin Speed: 1200 RPM
Product Dimension (WxDxH):
 440x595x850 mm
Package Dimension (WxDxH):
 500x655x885 mm
Net Weight (Kg): 55
Gross Weight (Kg): 58
Rated Power: 2050W
Market: UAE, Qatar

KEY FEATURES

Lunar Dial
 Broad Vision Port
 Hygiene 90°
 Quick Wash 15
 One-touch Pre-wash
 Mute the Beep
 Wash and Dry in One
 Auto Dry Technology
 ECO 40-60
 Rinse & Spin
 Extra Rinse



Child Lock



Hygiene 90°C



ECO 40-60



Lunar Dial



Quick Wash 15



Extra Rinse

6KG Front Load
MF100W60



SPECIFICATION

Capacity: 6 KG
Spin Capacity: 6 KG
Number of Program: 15
Color: White
Max Spin Speed: 1200 RPM
Product Dimension (WxDxH):
 440x595x850 mm
Package Dimension (WxDxH):
 500x655x885 mm
Net Weight (Kg): 52
Gross Weight (Kg): 54
Rated Power: 2050W
Market: UAE, Kuwait & Oman

KEY FEATURES

Lunar Dial
 Broad Vision Port
 Hygiene 90°C
 Quick Wash 15
 One-touch Pre-wash
 Mute the Beep
 Child Lock
 LED Display
 Rapid 45



Child Lock



LED Digital Display



Hygiene 90°C



Lunar Dial



Quick Wash 15

13KG Front Load Washer Dryer
MF205D130WB



SPECIFICATION

Capacity: 13 KG
Dryer Capacity: 8 KG
Number of Program: 15
Color: Titanium
Product Dimension (WxDxH):
 595x575x850 mm
Package Dimension (WxDxH):
 695x680x885 mm
Net Weight (Kg): 69
Gross Weight (Kg): 74
Rated Power: 1900W
Market: Kuwait, Qatar, Oman
 & Bahrain

KEY FEATURES

Health Guard
 Quick 45'/15'
 Perfume+
 WiFi
 Turbo
 Steam
 PowerGuard
 Child Lock



Child Lock



Quick Wash 15



Steam



PowerGuard



Wi-Fi

12KG Front Load Washer Dryer
MF200D120WB



SPECIFICATION

Capacity: 12 KG
Dryer Capacity: 8 KG
Color: Titanium
Max Spin Speed: 1400 RPM
Product Dimension (WxDxH):
 595x595x850 mm
Package Dimension (WxDxH):
 680x725x875 mm
Net Weight (Kg): 73
Gross Weight (Kg): 78
Rated Power: 2000W
Market: UAE, Kuwait, Oman & Qatar

KEY FEATURES

Wi-Fi Connectivity
 Auto Wash
 Steam Care
 Turbo
 Quick Wash 15
 Air Fresh
 Child Lock
 Pre-Wash
 Lunar Dial
 Wide Door



Child Lock



Wi-Fi



Turbo



Lunar Dial



Air Fresh



Quick Wash 15

11.5KG Front Load Washer Dryer
MF205D115WB



SPECIFICATION

Capacity: 11.5 KG
Dryer Capacity: 8 KG
Number of Program: 15
Color: Titanium
Product Dimension (WxDxH):
 595x575x850 mm
Package Dimension (WxDxH):
 695x680x885 mm
Net Weight (Kg): 69
Gross Weight (Kg): 74
Rated Power: 1900W
Market: UAE

KEY FEATURES

Health Guard
 Quick 45'/15'
 Perfume+
 WiFi
 Turbo
 Steam
 PowerGuard
 Child Lock



Child Lock



Wi-Fi



Quick Wash 15



Lunar Dial



PowerGuard



Steam

10KG Front Load Washer Dryer
MF200D100WB



SPECIFICATION

Capacity: 10 KG
Dryer Capacity: 7 KG
Color: Titanium
Max Spin Speed: 1400 RPM
Product Dimension (WxDxH):
 535x595x850 mm
Package Dimension (WxDxH):
 680x660x875 mm
Net Weight (Kg): 66
Gross Weight (Kg): 70
Rated Power: 2000W
Market: UAE, Kuwait,
 Oman & Qatar

KEY FEATURES

Wi-Fi Connectivity
 Auto Clean
 Steam Care
 Turbo
 Quick Wash 15
 Air Fresh
 Child Lock
 Wide Door
 Pre-Wash



Air Fresh



Child Lock



Hygiene 90°C



Quick Wash 15



Steam Care



Wi-Fi

10KG Front Load Washer Dryer
MF205D100WB



SPECIFICATION

Capacity: 10 KG
Dryer Capacity: 7 KG
Number of Program: 15
Color: Titanium
Product Dimension (W×D×H):
 595x555x850 mm
Package Dimension (W×D×H):
 680x660x885 mm
Net Weight (Kg): 67
Gross Weight (Kg): 71
Rated Power: 1880W
Market: UAE, Qatar, Bahrain,
 Oman & Kuwait

KEY FEATURES

Health Guard
 Quick 45'/15'
 Perfume+
 WiFi
 Turbo
 Steam
 PowerGuard
 Child Lock



Child Lock



Quick Wash 15



Wi-Fi



PowerGuard



Steam

8KG Front Load Washer Dryer
MF200D80WB/W



SPECIFICATION

Capacity: 8 KG
Dryer Capacity: 6 KG
Color: White
Max Spin Speed: 1400 RPM
Product Dimension (W×D×H):
 595x475x850 mm
Package Dimension (W×D×H):
 650x555x885 mm
Net Weight (Kg): 65
Gross Weight (Kg): 69
Rated Power: 1900W
Market: UAE, Kuwait,
 Bahrain & Qatar

KEY FEATURES

Wi-Fi Connectivity
 Auto Clean
 Steam Care
 Turbo
 Quick Wash 15
 Air Fresh
 Child Lock
 Pre-Wash
 Extra Rinse



Air Fresh



Child Lock



Wi-Fi



Quick Wash 15



Steam Care



Extra Rinse

8KG Front Load Washer Dryer
MF205D80WB



SPECIFICATION

Capacity: 8 KG
Dryer Capacity: 6 KG
Number of Program: 15
Color: Titanium
Product Dimension (W×D×H):
 595x555x850 mm
Package Dimension (W×D×H):
 680x660x885 mm
Net Weight (Kg): 67
Gross Weight (Kg): 71
Rated Power: 1900W
Market: UAE, Qatar, Bahrain
 Oman & Kuwait

KEY FEATURES

Health Guard
 Quick 45'/15'
 Perfume+
 WiFi
 Turbo
 Steam
 PowerGuard
 Child Lock



Turbo



Wi-Fi



PowerGuard



Quick Dry



Steam

8KG Front Load Washer Dryer
MF200D80WB/T



SPECIFICATION

Capacity: 8 KG
Dryer Capacity: 6 KG
Color: Titanium
Max Spin Speed: 1400 RPM
Product Dimension (WxDxH):
 595x475x850 mm
Package Dimension (WxDxH):
 650x555x885 mm
Net Weight (Kg): 65
Gross Weight (Kg): 69
Rated Power: 1900W
Market: UAE, Kuwait, Oman,
 Bahrain & Qatar

KEY FEATURES

Wi-Fi Connectivity
 Auto Clean
 Steam Care
 Turbo
 Quick Wash 15
 Air Fresh
 Child Lock
 Pre-Wash
 Extra Rinse



Air Fresh



Child Lock



Wi-Fi



Quick Wash 15



Steam Care



Extra Rinse

8KG Front Load Condenser Dryer
MD200C80W/W-GCC



SPECIFICATION

Capacity: 15 KG
Dryer Capacity: 8 KG
Number of Program: 9
Color: White
Product Dimension (WxDxH):
 595x615x845 mm
Package Dimension (WxDxH):
 660x680x880 mm
Net Weight (Kg): 41
Gross Weight (Kg): 43
Rated Power: 2200W
Market: Kuwait, Oman,
 Bahrain & Qatar

KEY FEATURES

Lunar Dial
 Health Guard
 Quick Dry
 Anti Crease
 Air Fresh
 Smart Cycle Selection



Lunar Dial



Quick Dry



Air Fresh



Child Lock

10KG Front Load Dryer
MD205H100W/T-GCC



SPECIFICATION

Capacity: 10 KG
Spin Capacity: 10 KG
Number of Program: 15
Color: Titanium
Product Dimension (WxDxH):
 595x680x850 mm
Package Dimension (WxDxH):
 710x745x890 mm
Net Weight (Kg): 50
Gross Weight (Kg): 54
Rated Power: 750W
Market: UAE, Qatar, Bahrain
 Oman & Kuwait

KEY FEATURES

Inverter
 Heat Pump
 Slot In Design
 WiFi
 Quick Dry
 Anti Crease
 Air Fresh



Child Lock



Hygiene+



Pulsator



Lunar Dial

10KG Front Load Dryer
MD210H100WB



SPECIFICATION

Capacity: 10 KG
Spin Capacity: 10 KG
Number of Program: 14
Color: Titanium
Product Dimension (W×D×H):
 595x685x850 mm
Package Dimension (W×D×H):
 712x760x895 mm
Net Weight (Kg): 53
Gross Weight (Kg): 58
Rated Power: 750W
Market: Qatar, Kuwait & UAE

KEY FEATURES

Heat Pump
 Dual Inverter
 Condenser Lint Self Cleaning
 Turbo
 Health Guard
 Reversible door
 Sensor Dry + Anti-crease
 LED Lunar Dial
 Slot In Design



Child Lock



Autosensing Electronic



Transparent Windows

19KG Top Load
MA516W190



SPECIFICATION

Capacity: 19 KG
Spin Capacity: 19 KG
Number of Program: 10
Color: Carbon Grey
Product Dimension (W×D×H):
 655x670x1075 mm
Package Dimension (W×D×H):
 700x715x1115 mm
Net Weight (Kg): 55
Gross Weight (Kg): 60
Rated Power: 600W
Market: Qatar, Bahrain, Oman & Kuwait

KEY FEATURES

Child Lock
 Tub Clean
 PowerMix Spray
 Space Master
 Turbo
 Quiet Tech
 Super Soft Close Lid



Child Lock



Turbo



Super Soft Close Lid

15KG Top Load
MA200W150DH/GK



SPECIFICATION

Capacity: 15 KG
Spin Capacity: 15 KG
Number of Program: 9
Color: Grey
Product Dimension (W×D×H):
 601x611x1015 mm
Package Dimension (W×D×H):
 660x685x1080 mm
Net Weight (Kg): 48
Gross Weight (Kg): 53
Rated Power: 1150W
Market: Kuwait, Oman, Bahrain & Qatar

KEY FEATURES

Lunar Dial
 Soft Close
 Independent Design for Softener
 Child Lock
 Matte Glass Lid
 Pulsator
 Save 20% Time
 Low Noise
 Hygiene+
 Water Cube Tub
 Fuzzy Logic Technology



Child Lock



Hygiene+



Pulsator



Lunar Dial

13KG Top Load
MA200W130DH/GK



SPECIFICATION

Capacity: 13 KG
Spin Capacity: 13 KG
Number of Program: 9
Color: Grey
Product Dimension (W×D×H):
 601×611×1015 mm
Package Dimension (W×D×H):
 660×685×1080 mm
Net Weight (Kg): 48
Gross Weight (Kg): 51
Rated Power: 1150W
Market: Kuwait, Oman & Qatar

KEY FEATURES

Lunar Dial
 Soft Close
 Independent Design
 for Softener
 Child Lock
 Matte Glass Lid
 Save 20% Time
 Low Noise
 Hygiene+
 Pulsator
 Water Cube Tub
 Fuzzy Logic Technology



Child Lock



Hygiene+



Pulsator



Lunar Dial

10KG Top Load
MA200W100



SPECIFICATION

Capacity: 10 KG
Spin Capacity: 10 KG
Number of Program: 8
Color: White
Product Dimension (W×D×H):
 550×565×935 mm
Package Dimension (W×D×H):
 623×634×1010 mm
Net Weight (Kg): 37
Gross Weight (Kg): 42
Rated Power: 600W
Market: Kuwait, Oman,
 Bahrain & Qatar

KEY FEATURES

Lunar Dial
 Soft Close
 Independent Design
 for Softener
 Child Lock
 Matte Glass Lid
 Save 20% Time
 Low Noise
 Hygiene+
 Pulsator
 Water Cube Tub
 Fuzzy Logic Technology



Child Lock



Hygiene+



Pulsator



Lunar Dial

18KG Twin Tub
MT100W180



SPECIFICATION

Capacity: 18 KG
Spin Capacity: 10 KG
Color: White
Product Dimension (W×D×H):
 995×555×1105 mm
Package Dimension (W×D×H):
 1020×580×1185 mm
Net Weight (Kg): 37.5
Gross Weight (Kg): 43.5
Rated Power: 680W
Market: Kuwait, Oman,
 Bahrain & Qatar

KEY FEATURES

Air Fresh
 Spin Timer
 Transparent Lid
 Air Drying
 Durable Body
 Magic Filter Pro
 Water Inlet Selection
 Dual Force Pulsator



Transparent Lid



Air Fresh



Spin Timer



Magic Filter Pro

17KG Twin Tub
MT100W170



SPECIFICATION

Capacity: 17 KG
Spin Capacity: 10 KG
Color: White
Product Dimension (W×D×H):
995×555×1105 mm
Package Dimension (W×D×H):
1020×580×1185 mm
Net Weight (Kg): 37.5
Gross Weight (Kg): 43.5
Rated Power: 620W
Market: UAE

KEY FEATURES

Air Fresh
Spin Timer
Transparent Lid
Air Drying
Durable Body
Magic Filter Pro
Water Inlet Selection
Dual Force Pulsator



Transparent Lid



Air Fresh



Spin Timer



Magic Filter Pro

14KG Twin Tub
MT100W140



SPECIFICATION

Capacity: 14 KG
Spin Capacity: 8 KG
Color: White
Product Dimension (W×D×H):
902×537×1050 mm
Package Dimension (W×D×H):
950×580×1090 mm
Net Weight (Kg): 30.5
Gross Weight (Kg): 36
Rated Power: 480W
Market: Kuwait, Oman & Qatar

KEY FEATURES

Air Fresh
Spin Timer
Transparent Lid
Air Drying
Durable Body
Magic Filter Pro
Water Inlet Selection
Dual Force Pulsator



Transparent Lid



Air Fresh



Spin Timer



Magic Filter Pro

12KG Twin Tub
MT100W120



SPECIFICATION

Capacity: 12 KG
Spin Capacity: 7 KG
Color: White
Product Dimension (W×D×H):
870×512×1020 mm
Package Dimension (W×D×H):
886×546×1055 mm
Net Weight (Kg): 26
Gross Weight (Kg): 30.5
Rated Power: 420W
Market: Kuwait, Oman,
Bahrain & Qatar

KEY FEATURES

Air Fresh
Spin Timer
Transparent Lid
Air Drying
Durable Body
Magic Filter Pro
Water Inlet Selection
Dual Force Pulsator



Transparent Lid



Air Fresh



Spin Timer



Magic Filter Pro

10KG Twin Tub
MT100W100



SPECIFICATION

Capacity: 10 KG
Spin Capacity: 6 KG
Color: White
Product Dimension (W×D×H):
827×485×975 mm
Package Dimension (W×D×H):
870×520×1020 mm
Net Weight (Kg): 23
Gross Weight (Kg): 28
Rated Power: 500W
Market: Kuwait, Oman & Qatar

KEY FEATURES

Air Fresh
Spin Timer
Transparent Lid
Air Drying
Durable Body
Magic Filter Pro
Water Inlet Selection
Dual Force Pulsator



Transparent Lid



Air Fresh



Spin Timer



Magic Filter Pro

8KG Twin Tub
MT100W80



SPECIFICATION

Capacity: 8 KG
Spin Capacity: 5 KG
Color: White
Product Dimension (W×D×H):
761×448×885 mm
Package Dimension (W×D×H):
778×475×920 mm
Net Weight (Kg): 20
Gross Weight (Kg): 23
Rated Power: 380W
Market: Kuwait, Oman

KEY FEATURES

Air Fresh
Spin Timer
Transparent Lid
Air Drying
Durable Body
Magic Filter Pro
Water Inlet Selection
Dual Force Pulsator



Transparent Lid



Air Fresh



Spin Timer



Magic Filter Pro

7KG Twin Tub
MT100W70



SPECIFICATION

Capacity: 7 KG
Spin Capacity: 4 KG
Color: White
Product Dimension (W×D×H):
735×430×845 mm
Package Dimension (W×D×H):
760×453×880 mm
Net Weight (Kg): 18.5
Gross Weight (Kg): 22
Rated Power: 380W
Market: Kuwait

KEY FEATURES

Air Fresh
Spin Timer
Transparent Lid
Air Drying
Durable Body
Magic Filter Pro
Water Inlet Selection
Dual Force Pulsator



Transparent Lid



Air Fresh



Spin Timer



Magic Filter Pro



*Make room
for what the heart
craves*

COOKING RANGE



MFO-MG36LE(SS)-C

Midea Cooking Ranges combine XpressRay Grill Burner feature top-of-the-line performance with iconic style to match any kitchen design. Choose from our range of gas and ceramic cooking ranges and hobs to cook delicious meals worth gathering around for.



LARGE ROOM FOR LARGE FAMILY FEASTS

The spacious oven fits large trays and multiple dishes comfortably. Perfect for weekend feasts and festive gatherings.



INFRARED BURNER - POWERFUL, STABLE, YET EFFICIENT

The infrared burner is a stable, safe and faster way of cooking. It's designed for high temperature cooking with even heat distribution for consistent results.



AESTHETICALLY CRAFTED, PRACTICALLY DESIGNED

A sleek stainless-steel finish paired with a modern control panel brings style to your kitchen while staying practical for everyday cooking.



SAFETY COMES FIRST

Electronic ignition ensures quick starts, while the flame failure device automatically cuts off gas if the flame goes out keeping your home safe, always.

90 cm Gas Cooker
MFO-MG36LE(SS)-C



SPECIFICATION

General Appearance:	Front Stainless Steel + Sides Silver
Cooktop:	5 Burners
Pan Support:	Cast Iron
Valve-Safety Device:	FFD & Oven Thermostat
Capacity & Cavity:	130L
Drawer Type:	Fold Down Drawer Without Handle
Functions:	Infrared Burner Flat Cavity with Hanging Racks Convection Fan for Airfry Even Heating Higher Temperature Ready in a Flash Stable & Safe
Door Type:	LOW-E Full Glass Door
Platform Size:	90*60
Oven Lamp:	Yes
Ignition:	Two-hand Electric Ignition
Timer:	Mechanical Timer
Product Size:	900×580×770 mm
Package Size:	936×696×845 mm
Loading (20'/40'/40 HQ):	40/80/120
Market:	UAE + GCC



Two-Hand Electric Ignition



Cast Iron



Mechanical Timer



Infrared Burner



Convection Fan for Airfry

90 cm Gas Cooker
MFO-MG36LE(SS)



SPECIFICATION

General Appearance:	Front Stainless Steel + Sides Silver
Cooktop:	5 Burners
Pan Support:	Cast Iron
Valve-Safety Device:	FFD & Oven Thermostat
Capacity & Cavity:	130L
Drawer Type:	Fold Down Drawer Without Handle
Functions:	Infrared Burner Flat Cavity with Hanging Racks Even Heating Higher Temperature Ready in a Flash Stable & Safe
Door Type:	LOW-E Full Glass Door
Platform Size:	90*60
Oven Lamp:	Yes
Ignition:	Two-hand Electric Ignition
Timer:	Mechanical Timer
Product Size:	900×580×770 mm
Package Size:	936×696×845 mm
Loading (20'/40'/40 HQ):	40/80/120
Market:	UAE + GCC



Two-Hand Electric Ignition



Cast Iron



Mechanical Timer



Infrared Burner

60 cm Gas Cooker
MFO-MG24TE(SS)-C



SPECIFICATION

General Appearance:	Stainless Steel
Cooktop:	4 Gas Burners
Pan Support:	Cast Iron
Valve-Safety Device:	FFD & Oven Thermostat
Capacity & Cavity:	70L
Drawer Type:	Fixed
Functions:	Extra Large Oven Capacity Easy Clean Glass Door with Large Window Premium Design Amazingly Rapid Burner Larger Cooking Zone Better Cooking Experience Convection Fan for Airfry Glass Door
Door Type:	Glass Door
Platform Size:	60*60
Oven Lamp:	Yes
Ignition:	Two-hand Electric Ignition
Timer:	Mechanical Timer
Product Size:	593×595×850 mm
Package Size:	648×680×885 mm
Loading (20'/40'/40 HQ):	54/108/162
Market:	UAE + GCC



4 Gas Burners



Cast Iron



Extra Large Oven Capacity



Easy Clean Glass Door



Convection Fan for Airfry



Two-Hand Electric Ignition



Mechanical Timer

60 cm Gas Cooker
MFO-MG24TE(SS)



SPECIFICATION

General Appearance:	Front Stainless Steel + Sides Silver
Cooktop:	4 Gas Burners
Pan Support:	Cast Iron
Valve-Safety Device:	FFD & Oven Thermostat
Capacity & Cavity:	70L
Drawer Type:	Fixed
Functions:	Extra Large Oven Capacity Easy Clean Glass Door with Large Window Premium Design Amazingly Rapid Burner Larger Cooking Zone Better Cooking Experience Glass Door
Door Type:	Glass Door
Platform Size:	60*60
Oven Lamp:	Yes
Ignition:	Two-hand Electric Ignition
Timer:	Mechanical Timer
Product Size:	593×595×850 mm
Package Size:	648×680×885 mm
Loading (20'/40'/40 HQ):	54/108/162
Market:	UAE + GCC



4 Gas Burners



Cast Iron



Extra Large Oven Capacity



Easy Clean Glass Door



Mechanical Timer



Two-Hand Electric Ignition

60 cm Gas Cooker
MFO-MG24TE-OL



SPECIFICATION

General Appearance:	Painted Silver
Cooktop:	4 Gas Burners
Pan Support:	Matte Enamel
Valve-Safety Device:	FFD
Capacity & Cavity:	70L
Drawer Type:	Fixed
Functions:	Extra Large Oven Capacity Easy Clean Glass Door with Large Window Premium Design Amazingly Rapid Burner Larger Cooking Zone Better Cooking Experience Single Knob for Grill & Oven
Door Type:	Glass Door
Platform Size:	60*60
Oven Lamp:	Yes
Ignition:	Two-Hand Electric Ignition
Timer:	No
Product Size:	593×595×850 mm
Package Size:	648×680×885 mm
Loading (20'/40'/40 HQ):	54/108/162
Market:	UAE + GCC



4 Gas Burners



Two-Hand Electric Ignition



Extra Large Oven Capacity



Easy Clean Glass Door



Mechanical Timer

50 cm Gas Cooker
MFO-MG20TE(SS)-FFD



SPECIFICATION

General Appearance:	Front Stainless Steel + Sides Silver
Cooktop:	4 Gas Seal Burners
Pan Support:	Matte Enamel
Valve-Safety Device:	FFD & Oven Thermostat
Capacity & Cavity:	62L
Functions:	Micro Flat-plate Heating Element FFD - Full Safety Feature with Grill a Considerate Burners Distribution Larger Cooking Zone Better Cooking Experience Easy Clean Glass Door with Large Window
Door Type:	Glass Door
Platform Size:	55*50
Oven Lamp:	Yes
Ignition:	Two-Hand Electric Ignition
Timer:	Mechanical Timer
Product Size:	493×556×850 mm
Package Size:	514×572×880 mm
Loading (20'/40'/40 HQ):	114/241/274
Market:	UAE



4 Gas Burners



Mechanical Timer



Easy Clean Glass Door

50 cm Gas Cooker
MFO-MG20TE(SS)



SPECIFICATION

General Appearance:	Front Stainless Steel + Sides Silver
Cooktop:	4 Gas Seal Burners
Pan Support:	Matte Enamel
Valve-Safety Device:	Stopcock
Capacity & Cavity:	62L
Functions:	Micro Flat-Plate Heating Element A Considerate Burners Distribution Larger Cooking Zone Better Cooking Experience Easy Clean Glass Door with Large Window Glass Door
Door Type:	Glass Door
Platform Size:	55*50
Oven Lamp:	No
Ignition:	Manual Ignition
Timer:	No
Product Size:	493×556×850 mm
Package Size:	514×572×880 mm
Loading (20'/40'/40 HQ):	114/241/274
Market:	GCC



4 Gas Burners



Easy Clean Glass Door



Manual Ignition

50 cm Gas Cooker
MFO-MG20TE(SS)-OL



SPECIFICATION

General Appearance:	Front Stainless Steel + Sides Silver
Cooktop:	4 Gas Seal Burners
Pan Support:	Matte Enamel
Valve-Safety Device:	FFD
Capacity & Cavity:	62L
Functions:	A Considerate Burners Distribution Larger Cooking Zone Better Cooking Experience Easy Clean Glass Door with Large Window Glass Door
Door Type:	Glass Door
Platform Size:	55*50
Oven Lamp:	No
Ignition:	Manual Ignition
Timer:	No
Product Size:	493×556×850 mm
Package Size:	514×572×880 mm
Loading (20'/40'/40 HQ):	114/241/274
Market:	UAE + GCC



4 Gas Burners



Easy Clean Glass Door



Manual Ignition

90 cm Ceramic Cooker
VSVC96048



SPECIFICATION

General Appearance:	Stainless Steel
Cooktop Heater Type:	Ceramic Hob
Capacity & Cavity:	102L Flat
Oven Door & Glass Type:	3 Layers Glass Door
Drawer Type:	Fold Down
Functions:	9 Functions: Lamp, Defrost, Double Grill with Fan, Radiant Heat, Convection with Fan, Conventional Cooking, Bottom Heater, Convection + Digital Timer, Rotisserie
Upper Oven Heater(Grill):	Electric & Radiant
Accessories:	1 Grill Rack, 1 Baking Tray
Cable & Plug:	No Plug
Electric Power:	11.94kW
Oven Power:	Top Heater: 1.0kW Bottom Heater: 1.7kW Radiant: 1.8kW Convection Heater: 2x1.2 kW
Product Size:	770x595x895 mm
Package Size:	845x687x956 mm
Market:	UAE + GCC



Ceramic Hob



Rotisserie



Double Grill with Fan



Bottom Heater



Convection + Timer

60 cm Ceramic Cooker
VC6814



SPECIFICATION

General Appearance:	Stainless Steel
Cooktop Heater Type:	Ceramic Hob
Capacity & Cavity:	65L Ribbed
Oven Door & Glass Type:	2 Layers Glass Door
Drawer Type:	Fold Down
Functions:	9 Functions: Oven Lamp, Defrost, Double Grill with Fan, Convection with Fan, Conventional Cooking, Bottom Heater, Grill (Small), Rotisserie, Mechanical Timer
Upper Oven Heater(Grill):	Electric & Radiant
Accessories:	1 Grill Rack, 1 Baking Tray
Cable & Plug:	No Plug
Electric Power:	6kW
Product Size:	600x660x850 mm
Package Size:	640x700x920 mm
Market:	UAE + GCC



Ceramic Hob



Defrost



Double Grill with Fan



Bottom Heater



Convection + Timer



Rotisserie



*Make room
for wonderful
memories*

MICROWAVE OVENS



EG142A5L

Discover an accomplished kitchen assistant with diverse powerful capabilities and wonderful features. From solo and grill microwave ovens to convection microwave ovens that let you cook and serve easily at the press of a button.

MICROWAVE OVEN



COMBINATION COOKING

The combination of microwave and grill helps achieve better food texture, tenderize the food, and add the desired char or sear marks, making your dishes truly exquisite.

PRE-SET AUTO MENUS

Auto menus make it easy to cook a variety of dishes without having to worry about cooking time or power levels. Simply select the appropriate auto menu, and the microwave does the rest, allowing you to attend other tasks.



DEFROST BY WEIGHT/TIME

Easily defrost meats and other types of food by setting optimal defrosting time and power level.



CHILD SAFETY LOCK

While our microwaves may be easy to use, it is no child's play. With child safety lock, keep the little ones from operating the microwave on their own.

42L Microwave Oven Grill Microwave
EG142A5L



SPECIFICATION

Cavity Size:	42L
Cavity Material:	Painted Grey
Outer Color:	Silver
Door Open:	Pull Handle Open
Control:	Membrane
Function:	Microwave + Grill
Microwave Input Power:	1550W
Microwave Output Power:	1100W
Grill Power:	1200-1400W
Microwave Power Levels:	11
Maximum Cooking Time:	99'99"
Auto Menus:	7
Cooking End Signal:	Yes
Child Safety Lock:	Yes
Turntable Diameter:	345mm
Cavity Dimension: (W×D×H)	260×412×394 mm
Product Dimension: (W×D×H)	327×440×553 mm
Loading Qty: (40/'40/'20HQ)	574/492/240
Market:	UAE + GCC



Child Safety Lock



Pull Handle Open



Microwave + Grill



Membrane

42L Microwave Oven Solo Microwave
EM142A2MI-S



SPECIFICATION

Cavity Size:	42L
Cavity Material:	Painted Steel
Outer Color:	Grey
Door Open:	Pull Handle
Control:	Membrane
Function:	Microwave
Microwave Input Power:	1550W
Microwave Output Power:	1100W
Microwave Power Levels:	5
Maximum Cooking Time:	99'99"
Auto Menus:	21
Cooking End Signal:	Yes
Child Safety Lock:	Yes
Turntable Diameter:	345mm
Product Dimension: (W×D×H)	553×433×329 mm
Loading Qty: (40/'40/'20HQ)	240/480/575
Market:	UAE + GCC



LED Display



Child Safety Lock



Digital Control

62L Microwave Oven Solo Microwave
MMO-EM62AW(BK)

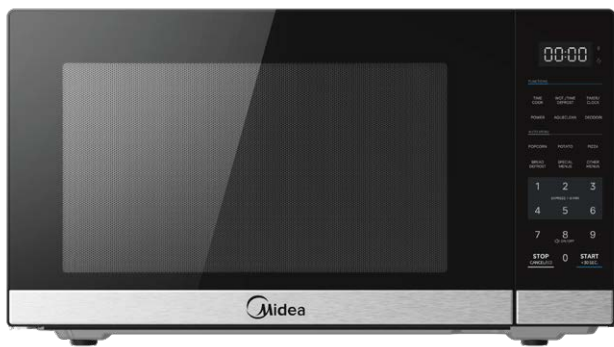

SPECIFICATION

Cavity Size:	62L
Cavity Material:	Painted Grey
Outer Color:	Black
Door Open:	Press Button Open
Control:	Digital
Function:	Microwave
Microwave Input Power:	1800W
Microwave Output Power:	1200W
Microwave Power Levels:	5
Maximum Cooking Time:	99'99"
Auto Menus:	21
Cooking End Signal:	Yes
Child Safety Lock:	Yes
Turntable Diameter:	420mm
Product Dimension: (WxDxH)	620x550x346 mm
Loading Qty: (40/'40/'20HQ)	160/340/400
Market:	UAE + GCC



Child Safety Lock



Press Button Open



Digital Control

29L Microwave Oven Solo Microwave
EM9P032MX



SPECIFICATION

Cavity Size:	29L
Cavity Material:	Painted Grey
Outer Color:	Dark Silver
Door Open:	Pull Handle Open
Control:	Membrane
Function:	Microwave
Microwave Input Power:	1400W
Microwave Output Power:	900W
Microwave Power Levels:	6
Maximum Cooking Time:	99'99"
Auto Menus:	7
Cooking End Signal:	Yes
Child Safety Lock:	Yes
Turntable Diameter:	288mm
Cavity Dimension: (WxDxH)	251.5x347.6x330 mm
Product Dimension: (WxDxH)	290x396x495 mm
Loading Qty: (40/'40/'20HQ)	880/770/371
Market:	UAE + GCC



Child Safety Lock



+30s Express Start



ECO Mode



Electronic Touch Control

25L Microwave Oven Solo Microwave
MM8P022KG-BK



SPECIFICATION

Cavity Size:	25L
Cavity Material:	Painted Grey
Outer Color:	Black
Door Open:	Pull Handle Open
Control:	Manual
Function:	Microwave
Microwave Input Power:	1250W
Microwave Output Power:	800W
Microwave Power Levels:	5
Maximum Cooking Time:	99'99"
Cooking End Signal:	Yes
Turntable Diameter:	288mm
Cavity Dimension: (WxDxH)	218x328x326 mm
Product Dimension: (WxDxH)	280x381x469 mm
Loading Qty: (40/'40/'20HQ)	990/865/411
Market:	UAE + GCC



Child Safety Lock



+30s Express Start



LED Electronic Touch Control



Pull Handle Open

25L Microwave Oven Solo Microwave
EM925A2GU-SL



SPECIFICATION

Cavity Size:	25L
Cavity Material:	Painted Grey
Outer Color:	Silver
Door Open:	Pull Handle Open
Control:	Membrane
Function:	Microwave
Microwave Input Power:	1450W
Microwave Output Power:	900W
Microwave Power Levels:	11
Maximum Cooking Time:	99'99"
Auto Menus:	6
Cooking End Signal:	Yes
Child Safety Lock:	Yes
Turntable Diameter:	270mm
Cavity Dimension: (WxDxH)	221x347x314 mm
Product Dimension: (WxDxH)	292.5x409x485 mm
Loading Qty: (40/'40/'20HQ)	910/804/391
Market:	UAE + GCC



Child Safety Lock



+30s Express Start



LED Electronic Touch Control



Pull Handle Open

20L Microwave Oven Solo Microwave
MM7P012MZ-W / MM7P012MZ-BK



SPECIFICATION

Cavity Size:	20L
Cavity Material:	Painted Grey
Outer Color:	White / Black
Door Open:	Press Button Open
Control:	Mechanical
Function:	Solo Microwave
Microwave Input Power:	700W
Microwave Output Power:	1020W
Microwave Power Levels:	700W
Maximum Cooking Time:	35'
Turntable Diameter:	245mm
Cavity Dimension: (WxDxH)	280x280x175 mm
Product Dimension: (WxDxH)	434x329x241 mm
Loading Qty: (40/'40/'20HQ)	1713/1376/656
Market:	UAE + GCC



Inverter Quattro



Easy Cleaning Cavity



Energy Saving



Press Button Open

20L Microwave Oven Solo Microwave
EM721BK



SPECIFICATION

Cavity Size:	20L
Cavity Material:	Painted Grey
Outer Color:	Black
Door Open:	Press Button Open
Control:	Membrane
Function:	Microwave
Microwave Input Power:	1050W
Microwave Output Power:	700W
Microwave Power Levels:	11
Maximum Cooking Time:	99'99"
Auto Menus:	6
Cooking End Signal:	Yes
Child Safety Lock:	Yes
Turntable Diameter:	255mm
Cavity Dimension: (WxDxH)	206x307x304 mm
Product Dimension: (WxDxH)	258.2x334.2x439.5 mm
Loading Qty: (40/'40/'20HQ)	1470/1295/645
Market:	UAE + GCC



Child Safety Lock



Digital Control



Membrane



Press Button Open

29L Microwave Oven Grill Microwave
EG9P032MX



SPECIFICATION

Cavity Size:	29L
Cavity Material:	Painted Grey
Outer Color:	Dark Silver
Door Open:	Pull Handle Open
Control:	Membrane
Function:	Microwave + Grill
Microwave Input Power:	1450W
Microwave Output Power:	900W
Grill Power:	1000W
Microwave Power Levels:	11
Maximum Cooking Time:	99'99"
Auto Menus:	10
Cooking End Signal:	Yes
Child Safety Lock:	Yes
Turntable Diameter:	288mm
Cavity Dimension: (W×D×H)	251.5×347.6×330 mm
Product Dimension: (W×D×H)	495×396×290 mm
Loading Qty: (40/'40/'20HQ)	880/770/371
Market:	UAE + GCC



Child Safety Lock



+30s Express Start



Electronic Touch Control



Pull Handle Open



*Make room
for more moments
together*

DISHWASHERS



WQP15-WU7633GUR-BS

Midea's award-winning Dishwashers are designed with features that eliminate 99.99% germs and odors through high-temperature washing, while setting the standard in energy and water saving. Choose from our range of free-standing, built-in and compact table-top dishwashers that fit your family, and enjoy spotless, hygienically clean crockery, cutlery and cookware.



DISHWASHER



AUTO OPEN DOOR

Active Open Dry allows the door to open slightly at the end of the cycle so as to lower temperature inside. This lets inside moisture escape quickly, leaving your dishes a lot drier, naturally.

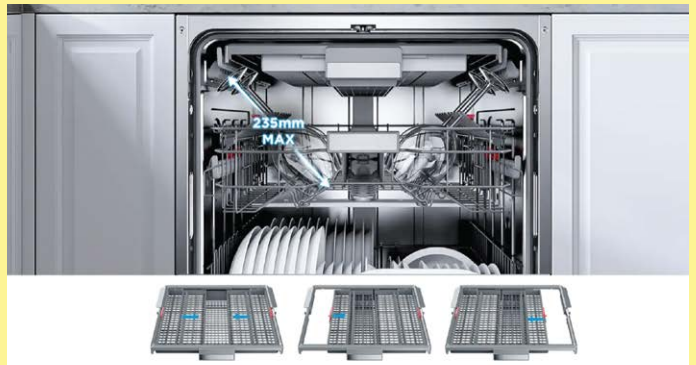

NEWFLEX 3 RACK SYSTEM

With the loading flexibility of a 3rd drawer, you can easily accommodate large utensils or tall glasses and cups in the upper basket.

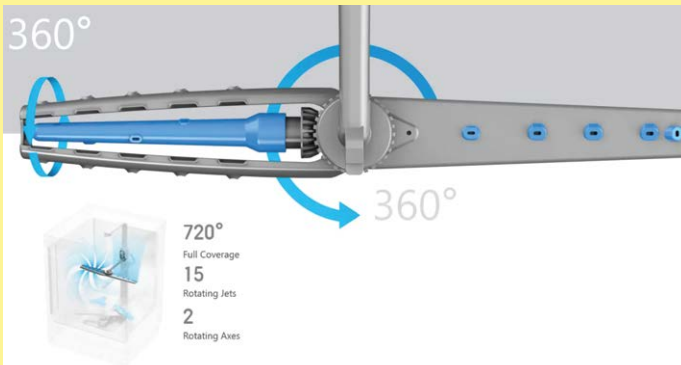

INNOWASH PRO SPRAY ARM

The unique Innowash Pro Spray Arm comes equipped with 15 sprayers and an additional vertical axis, which rotates 720° to flush away every single stain, leaving your dishes sparkling clean.

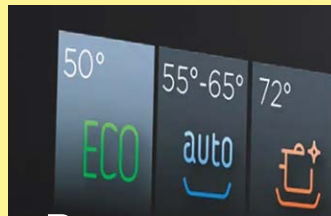

Radiant colours



Effortless control

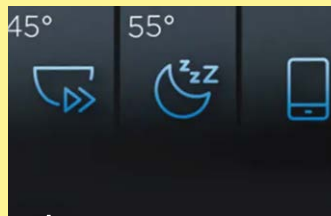

Apparent images



Luxurious style

15 PS Free Standing Dishwasher
WQP15-WU7633GUR-BS



SPECIFICATION

Capacity: 15 Place Settings
Color: Black Steel
Number of Programs: 9
Noise Level: 42 dBA
Product Dimension (WxDxH):
 598x600x845 mm
Package Dimension (WxDxH):
 645x645x890 mm
Net Weight (Kg): 51
Gross Weight (Kg): 55.8
Market: UAE & Iraq

KEY FEATURES

MSmartLife
 Intensive Wash
 Innowash Pro Spray Arm
 3-Level Height Adjustable
 Golden Hygiene
 Efficient, Energy-Saving,
 Extremely Quiet
 Newflex 3rd Rack
 Auto Open door



MSmartLife



Intensive Wash



Innowash Pro
Spray Arm



Anti-Bacterial
Technology



Remove
Odors & Germs



Extremely
Quiet



UV LED
Anti-Bacterial-
Technology



Active Open

15 PS Free Standing Dishwasher
WQP15-W7633D-SS



SPECIFICATION

Capacity: 15 Place Settings
Color: Stainless Steel
Number of Programs: 9
Noise Level: 44 dBA
Product Dimension (WxDxH):
 598x600x845 mm
Package Dimension (WxDxH):
 645x645x890 mm
Net Weight (Kg): 45.5
Gross Weight (Kg): 49.5
Market: UAE & Lebanon

KEY FEATURES

Innowash Pro Spray Arm
 3-Level Height Adjustable
 Newflex 3rd Rack
 Effectively Remove
 Odors & Germs
 MSmartLife
 Auto Open door
 Child Lock



Innowash Pro
Spray Arm



Remove
Odors & Germs



MSmartLife



Anti-Bacterial
Technology



Active Open

14 PS Free Standing Dishwasher
WQP14-W7633C-S / W / B



SPECIFICATION

Capacity: 14 Place Settings
Color: Silver / White / Black
Number of Programs: 8
Noise Level: 49 dBA
Product Dimension (WxDxH):
 598x600x845 mm
Package Dimension (WxDxH):
 645x645x890 mm
Net Weight (Kg): 39.6
Gross Weight (Kg): 46.1
Market: UAE, Iraq, Jordan & Palestine

KEY FEATURES

MSmartLife
 Intensive Wash
 Half Load
 ABT Filter Anti-Bacterial
 Technology
 Newflex 3rd Rack



MSmartLife



Intensive Wash



Half Load



Anti-Bacterial
Technology



Active Open

14 PS Free Standing Dishwasher

WQP14-W7633D-SS / W



SPECIFICATION

Capacity: 14 Place Settings
Color: Stainless Steel / White
Number of Programs: 9
Noise Level: 44 dBA
Product Dimension (WxDxH): 598x600x845 mm
Package Dimension (WxDxH): 645x645x890 mm
Net Weight (Kg): 39.6
Gross Weight (Kg): 46.1
Market: UAE, Iraq, & Palestine

KEY FEATURES

MSmartLife
 Intensive Wash
 Auto Open Door
 Innowash Pro Spray Arm
 3-Level Height Adjustable
 ABT Filter Anti-Bacterial Technology
 Effectively Remove Odors & Germs
 Newflex 3rd Rack
 Anti-Bacterial Technology



MSmartLife



Intensive Wash



Innowash Pro Spray Arm



Anti-Bacterial Technology



Remove Odors & Germs



Active Open

14 PS Free Standing Dishwasher

WQP14-W5233C-S / W

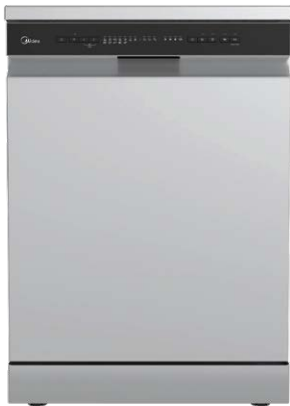

SPECIFICATION

Capacity: 14 Place Settings
Color: Silver / White
Number of Programs: 8
Noise Level: 49 dBA
Product Dimension (WxDxH): 598x600x845 mm
Package Dimension (WxDxH): 645x645x890 mm
Net Weight (Kg): 39
Gross Weight (Kg): 45.5
Market: UAE, Qatar, Syria & Palestine

KEY FEATURES

MSmartLife
 Intensive Wash
 Half Load
 3-Stage Active Drying
 Auto Open Door
 Child Lock



MSmartLife



Intensive Wash



Half Load



Anti-Bacterial Technology



Active Open

14 PS Free Standing Dishwasher

WQP14-5201C-S / W



SPECIFICATION

Capacity: 14 Place Settings
Color: Silver / White
Number of Programs: 6
Noise Level: 55 dBA
Product Dimension (WxDxH): 598x600x845 mm
Package Dimension (WxDxH): 645x645x890 mm
Net Weight (Kg): 39.5
Gross Weight (Kg): 43
Market: Qatar, Bahrain, Iraq, Lebanon, Jordan & Kuwait

KEY FEATURES

Half Load
 Flexible Intallation
 Intensive Wash
 Delicate Glass Care
 Quick Wash
 Offpeak Wash
 Child Lock
 Auto Open Door
 Eco-Dishwashing



Half Load



Intensive Wash



Quick-Wash



Child Lock



Eco Dishwashing



Active Open

13 PS Free Standing Dishwasher
WQP13-W5233CS



SPECIFICATION

Capacity: 13 Place Settings
Color: Silver
Number of Programs: 10
Noise Level: 52 dBA
Product Dimension (WxDxH):
 598x600x845 mm
Package Dimension (WxDxH):
 645x645x890 mm
Net Weight (Kg): 39
Gross Weight (Kg): 43
Market: UAE & GCC

KEY FEATURES

Half Load
 Msmartlife
 Child Lock
 Delicate Glass Care
 Intensive wash
 Eco-dishwashing
 Anti-Bacterial Filter



Intensive Wash



MSmartLife



Half Load



Child Lock

8 PS Counter Top Dishwasher
WQP8-3802F-S



SPECIFICATION

Capacity: 8 Place Settings
Color: Silver
Number of Programs: 7
Noise Level: 49 dBA
Product Dimension (WxDxH):
 550x500x590 mm
Package Dimension (WxDxH):
 605x555x662 mm
Net Weight (Kg): 26
Gross Weight (Kg): 30
Market: UAE & Kuwait

KEY FEATURES

Portable Dishwasher
 Intensive Wash
 Inverter Quattro
 Rapid Wash
 24-Hour Delay Start
 70° Degree Intensive Wash
 Child Lock



Intensive Wash



Rapid Wash



24-Hour Delay Start



Child Lock

8 PS Counter Top Dishwasher
WQP8-3802T



SPECIFICATION

Capacity: 8 Place Settings
Color: Black
Number of Programs: 8
Noise Level: 49 dBA
Product Dimension (WxDxH):
 550x500x590 mm
Package Dimension (WxDxH):
 605x555x662 mm
Net Weight (Kg): 26
Gross Weight (Kg): 30
Market: UAE

KEY FEATURES

Compact Body
 Auto Open Dry
 Extended Dry
 24 Hour Delay Start
 Flexible Rack System
 Child Lock
 Self Cleaning



24-Hour Delay Start



Child Lock



Auto Open Dry

6 PS Counter Top Dishwasher
WQP6-3609(GN)-G / W



SPECIFICATION

Capacity: 6 Place Settings
Color: Green / White
Number of Programs: 7
Noise Level: 49 dBA
Product Dimension (WxDxH):
550x515x464 mm
Package Dimension (WxDxH):
605x555x515 mm
Net Weight (Kg): 21.5
Gross Weight (Kg): 24
Market: UAE, Kuwait & Oman

KEY FEATURES

Auto Open Drying
Touch Control
Rapid Wash
Flexible Installation
Quick & Max Loading System



Rapid Wash



Flexible Installation



Active Open





*Make room
for healthy
living*

WATER DISPENSERS

Midea Water Dispensers have been designed to take care of your family, meticulously. Crafted from food-grade materials, our water dispensers ensure a refreshing, safe and reliable drinking experience.



YLSP01

Bottom Load - Ice Dispenser
YLSP01



SPECIFICATION

Cold Water Capacity/Output:
1.7L, 2L/H
Hot Water Capacity/Output:
1L, 4L/H
Color: Black
Product Dimension (W×D×H):
310×360×1040 mm
Package Dimension (W×D×H):
358×386×1160 mm
Net Weight (Kg): 17.7
Gross Weight (Kg): 20.7
Market: UAE, Qatar & Kuwait

KEY FEATURES

3 Temperature Water Selection
 Glittering of Your Iced Drinks
 Ice-making Flow Freezer
 Unstoppable Supply of Ice
 Stainless Steel Evaporator
 Child Safety Lock



Child Safety Lock



3 Water Temperature



Ice-making Flow Freezer



Bottom Loading



Crystal Ice Bullet



Antibacteria Materials for Operation Area

Bottom Load
YL1844S



SPECIFICATION

Cold Water Capacity/Output:
3.6L, 2.5L/H
Hot Water Capacity/Output:
1L, 4L/H
Color: Black
Product Dimension (W×D×H):
310×360×1040 mm
Package Dimension (W×D×H):
358×396×1120 mm
Net Weight (Kg): 18
Gross Weight (Kg): 21
Market: UAE & Kuwait

KEY FEATURES

Touchless Function
 Child Safety Lock
 3 Temperature Water Selection



Child Safety Lock



3 Water Temperature



Bottom Loading

Bottom Load
YL2036S(B)



SPECIFICATION

Cold Water Capacity/Output:
3.6L, 4L/H
Hot Water Capacity/Output:
1.16L, 4L/H
Color: Black
Product Dimension (W×D×H):
310×360×1040 mm
Package Dimension (W×D×H):
358×386×1160 mm
Net Weight (Kg): 15.6
Gross Weight (Kg): 16.3
Market: UAE, Lebanon, Qatar, Jordan & Kuwait

KEY FEATURES

3 Water Temperature
 4L/H Stronger Cooling Capacity
 20% Reduced Cooling Time
 7% Less Energy Consumption
 Anti-Bacterial Materials for Operation Area
 Child Safety Lock



Child Safety Lock



Bottom Loading



Antibacteria Materials for Operation Area



3 Water Temperature



7% Less Energy Consumption

Bottom Load
YL1633S



SPECIFICATION

Cold Water Capacity/Output:
3.6L, 2.5L/H
Hot Water Capacity/Output:
1.16L, 4L/H
Color: Black
Product Dimension (W×D×H):
310×360×1040 mm
Package Dimension (W×D×H):
358×386×1120 mm
Net Weight (Kg): 16.4
Gross Weight (Kg): 18.4
Market: UAE, Qatar, Syria & Lebanon

KEY FEATURES

Ice Cold Technology
Empty Bottle Indicator
3 Water Temperature
Child Safety Lock



Child Safety Lock



3 Water Temperature



Bottom Loading

Top Load
YL2037S-B



SPECIFICATION

Cold Water Capacity/Output:
3L - 2L/H
Hot Water Capacity/Output:
1.02L - 4L/H
Color: Black
Product Dimension (W×D×H):
310×350×1000 mm
Package Dimension (W×D×H):
358×386×1050 mm
Net Weight (Kg): 15.2
Gross Weight (Kg): 17.2
Market: Iraq, UAE & Kuwait

KEY FEATURES

3 Water Temperature
20L Cabinet with Refrigerator
Child Safety Lock
One Press to Go Green
EPA-Certified
Anti-Bacterial Materials for Operation Area
Food Grade Materials



Child Safety Lock



3 Water Temperature



Top Loading



20L Large-Capacity Cabinet



Antibacteria Materials for Operation Area

Top Load
YL2037S-W



SPECIFICATION

Cold Water Capacity/Output:
3L - 2L/H
Hot Water Capacity/Output:
1.02L - 4L/H
Color: White
Product Dimension (W×D×H):
310×360×1000 mm
Package Dimension (W×D×H):
358×386×1050 mm
Net Weight (Kg): 15.2
Gross Weight (Kg): 17.2
Market: UAE

KEY FEATURES

3 Water Temperature
20L Large-Capacity Cabinet
EPA-Certified
Anti-Bacterial Materials for Operation Area
Child Safety Lock



Child Safety Lock



3 Water Temperature



Top Loading



20L Large-Capacity Cabinet



Antibacteria Materials for Operation Area

Top Load
YL2381S-B



SPECIFICATION

Cold Water Capacity/Output:
3L, 2L/H
Hot Water Capacity/Output:
1.02L, 4L/H
Color: Black / White
Product Dimension (W×D×H):
310×355×1000 mm
Package Dimension (W×D×H):
360×408×1055
Net Weight (Kg): 16
Gross Weight (Kg): 18
Market: Iraq

KEY FEATURES

6-10°C Cold Water
Room Temperature Water
Up to 92°C Hot Water
3 Water Temperature
Auxiliary Side Handles
Cabinet with Refrigerator



20L
Large-Capacity
Cabinet



Top
Loading

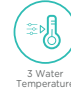

3 Water
Temperature

Top Load
YL2580S



SPECIFICATION

Cold Water Capacity/Output:
3L, 2L/H
Hot Water Capacity/Output:
1.02L, 4L/H
Color: Black/White
Product Dimension (W×D×H):
310×360×1000 mm
Package Dimension (W×D×H):
358×386×1050 mm
Net Weight (Kg): 14.6
Gross Weight (Kg): 16.5
Market: UAE, GCC & Iraq

KEY FEATURES

3 Water Temperature
Large-Capacity Cabinet
Optional Refrigerator
Paddle Push Buttons
High Dispensing Area
Anti-Bacterial Materials
for Operation Area



Compressor
Cooling



Child Safety
Lock



Prevents
Overheating

Top Load
YL1917S-AE(BK) / (W)



SPECIFICATION

Cold Water Capacity/Output:
3L, 2L/H
Hot Water Capacity/Output:
0.77L, 4L/H
Color: White / Black
Product Dimension (W×D×H):
310×360×1000 mm
Package Dimension (W×D×H):
360×404×1065 mm
Net Weight (Kg): 13.1
Gross Weight (Kg): 14.7
Market: UAE, Oman & Lebanon

KEY FEATURES

3 Water Temperature
Prevents Overheating
Stainless Steel Tank
3 Taps
Child Safety Lock



Child Safety
Lock



3 Water
Temperature



Top
Loading



Prevents
Overheating



Stainless Steel
Tank

Top Load

YL2436S-W / (W) / (B)



SPECIFICATION

Cold Water Capacity/Output:
2L, 2L/H
Hot Water Capacity/Output:
0.8L, 4L/H
Color: White / Black
Product Dimension (W×D×H):
310×360×996 mm
Package Dimension (W×D×H):
358×396×1050 mm
Net Weight (Kg): 15.3
Gross Weight (Kg): 17.2
Market: UAE, Kuwait, Oman, Qatar,
Lebanon, Jordan & Syria

KEY FEATURES

2 Water Temperature
Child Safety Lock
Extra Large 35L Cabinet
Cup-Push Dispense
Compressor Cooling
High Dispensing Area



Compressor
Cooling



Top
Loading



2 Water
Temperature



Cup-push
Dispense



Extra Large
35L Cabinet

Top Load

YL1675S



SPECIFICATION

Cold Water Capacity/Output:
2L, 2L/H
Hot Water Capacity/Output:
0.77L, 4L/H
Color: White
Product Dimension (W×D×H):
310×362×1000 mm
Package Dimension (W×D×H):
358×386×1095 mm
Net Weight (Kg): 13.9
Gross Weight (Kg): 15.8
Market: UAE

KEY FEATURES

2 Water Temperature:
Hot/Cold
Stainless Steel Tank
Ice Cold Technology
Prevents Overheating
Child Safety Lock



Child Safety
Lock



2 Water
Temperature



Prevents
Overheating



Top
Loading



Stainless Steel
Tank

Table Top

YL1635T



SPECIFICATION

Cold Water Capacity/Output:
3L, 2L/H
Hot Water Capacity/Output:
1.02L, 4L/H
Color: White
Product Dimension (W×D×H):
310×345×506 mm
Package Dimension (W×D×H):
362×425×570 mm
Net Weight (Kg): 11.8
Gross Weight (Kg): 13.5
Market: UAE, Kuwait & Jordan

KEY FEATURES

3 Water Temperature
Stainless Steel Tank
3 Taps
Prevents Overheating
Child Safety Lock



3 Water
Temperature



Child Safety
Lock



Prevents
Overheating

Table Top
YL2037T



SPECIFICATION

Cold Water Capacity/Output:
3L, 2L/H

Hot Water Capacity/Output:
1.02L, 4L/H

Color: White

Product Dimension (W×D×H):
310×345×506 mm

Package Dimension (W×D×H):
362×425×570 mm

Net Weight (Kg): 12

Gross Weight (Kg): 13.3

Market: Iraq

KEY FEATURES

3 Water Temperature
1 Faucet (Hot, Normal, Cold Water)
Tri-Temp Push Button
Child Safety Lock
LED Light Indicators
Energy Saving



3 Water Temperature



Child Safety Lock



Prevents Overheating



LED Light Indicators



Stainless Steel Tank

A person wearing white pants and sandals is using a cordless stick vacuum cleaner to clean under a white cabinet. The vacuum is black and silver, with a clear dust container. The scene is set against a light blue wall and a dark floor. The vacuum is positioned under the cabinet, and the person's hand is on the handle.

*Make room
for cleaner
homes*

VACUUM CLEANERS



MC08MEBU

Midea Vacuum Cleaners are designed to deliver a comfortable, effortless cleaning experience while helping you maintain a healthier living environment. With powerful performance and user-friendly features, we make it easier for you to keep your home fresh, clean, and dust-free, every day.

0.3L Robot Vacuum Cleaner
V15 MAX ULTRA



SPECIFICATION

Battery: 5200
Dust Collector Capacity: 0.3L
Product Dimension (WxDxH):
 354x355x110 mm
Package Dimension (WxDxH):
 548x475x528 mm
Net Weight (Kg): 14.07
Gross Weight (Kg): 19.89

KEY FEATURES

Sweep Mop Vacuum Type,
 Self-cleaning Bagged Station +
 Water Station
 Self-washing and Self-Emptying
 Self-Cleaning Base Station
 Auto Tank Refilling
 75°C Hot Water Mop Washing
 55°C Hot Air Mop Drying
 Roller Brush Lift and Mop Lift
 FlexiRazor™ Anti-Hair Tangling +
 Side Brush Anti-Tangling
 Advanced Edge Cleaning
 with Scrub Extend + Side Brush
 Extend
 Obstacle Crossing Height 4cm



0.3L Robot Vacuum Cleaner
V15 EVO ULTRA



SPECIFICATION

Battery: 6400
Dust Collector Capacity: 0.3L
Product Dimension (WxDxH):
 354x355x110
Package Dimension (WxDxH):
 548x475x528
Net Weight (Kg): 14.63
Gross Weight (Kg): 19.4

KEY FEATURES

Mopping
 Sweeping and Vacuuming
 LDS Navigation, 22000PA
 Base Station
 (Water: 4L+3.4LL+dust:3L)
 Self-Washing and Self-Emptying
 Hot Air Drying
 Extendable Mop Arm
 Edge Cleaning
 Carpet Recognition,
 Auto-Mop Life (12mm)
 Side Brush Anti-Tangling



360ml Robot Vacuum Cleaner
5200mAh/S8+



SPECIFICATION

Battery: 5200mAh
Water Tank Capacity: 360 ml
Product Dimension (WxDxH):
 490x490x400 mm
Net Weight (Kg): 8.7
Gross Weight (Kg): 12.5

KEY FEATURES

Powerful Suction
 + High Frequency Vibration
 Mopping for Better Cleaning
 Hands Free Dust Collection
 Station with Auto Docking &
 Charging Smart App Control
 & Intelligent LDS Based Mapping
 4000PA Strong BLDC Motor
 Powerfully Removes Dust
 from Crevices



450ML Robot Vacuum Cleaner
2600mAh | i5C



SPECIFICATION

Battery: 2600mAh
Water Tank Capacity: 450 ml
Product Dimension (WxDxH):
 340x340x83 mm
Package Dimension (WxDxH):
 465x395x153 mm
Net Weight (Kg): 3
Gross Weight (Kg): 4.8

KEY FEATURES

Three Suction Levels
 Smart App Control &
 Intelligent LDS Based Mapping
 Multi-Cleaning Modes
 Different Cleaning Modes
 Washable Dustbin
 4000PA NIDEC BLDC Motor
 Adjustable Mopping



450ML Robot Vacuum Cleaner
2600mAh | i5C



SPECIFICATION

Battery: 2600mAh
Water Tank Capacity: 450 ml
Product Dimension (WxDxH):
 340x340x83 mm
Package Dimension (WxDxH):
 465x395x153 mm
Net Weight (Kg): 3
Gross Weight (Kg): 4.8

KEY FEATURES

Three Suction Levels
 Smart App Control & Intelligent LDS Based Mapping
 Multi-Cleaning Modes
 Different Cleaning Modes
 Washable Dustbin
 4000PA NIDEC BLDC Motor
 Adjustable Mopping



Smart App & Intelligent Mapping



Multi-Cleaning Modes



Washable Dustbin



4000Pa Strong BLDC Motor



Battery 5200mAh

180ML Robot Vacuum Cleaner
5200mAh | M7Pro



SPECIFICATION

Battery: 5200mAh
Water Tank Capacity: 180 ml
Product Dimension (WxDxH):
 350x350x97 mm
Net Weight (Kg): 3.5
Gross Weight (Kg): 6.4

KEY FEATURES

More Power, Better Clean
 Smart App Control & Intelligent LDS Based Mapping
 Large Capacity Battery
 Different Cleaning Modes
 Auto Charging
 4000PA Motor



Smart App & Intelligent Mapping



4000Pa Strong BLDC Motor



Battery 5200mAh

0.6L Floor Cleaner
AT6 Ultra



SPECIFICATION

Power (W): 250
Dust Collector Capacity (L): 0.6
Water Collector Capacity (L): 0.75
Product Dimension (WxDxH):
 235x9720x270 mm
Package Dimension (WxDxH):
 314x340x750 mm
Net Weight (Kg): 7.8
Gross Weight (Kg): 11.6

KEY FEATURES

Forward And Backward Self-Propelling
 Triple Edge Cleaning
 Smart Detection+LED Screen
 180° Lay Flat
 100°C Heated Water Self Cleaning
 75°C Hot Air Self Drying
 Deodorizing Module



2-in-1 Design



Multi-Cleaning Modes



Forward and Backward



Deodorizing Module

0.6L Floor Cleaner
AT2



SPECIFICATION

Power (W): 200
Dust Collector Capacity (L): 0.6
Water Collector Capacity (L): 0.65
Product Dimension (WxDxH):
 1101.5x217.8x270.4 mm
Package Dimension (WxDxH):
 324x270x760 mm
Net Weight (Kg): 3.93
Gross Weight (Kg): 7.93

KEY FEATURES

Light Weight
 Low Lying Design
 Anti Tangle Brush
 Self Drying
 BLDC Motor
 Vacuum and Mop in One Step
 Large Water Tank
 Forward Self-Propelling



2-in-1 Design



Multi-Cleaning Modes



Forward Self-Propelling

0.55L Hand Stick Vacuum Cleaner
24P-P9



SPECIFICATION

Power (W): 170
Capacity (L): 0.55
Product Dimension (WxDxH):
 329x115x225 mm
Package Dimension (WxDxH):
 660x280x205 mm
Net Weight (Kg): 3.27
Gross Weight (Kg): 5.04

KEY FEATURES

2-in-1 Design
 Multi-Cleaning
 Stick & Hand Held
 Transparent Dust Cup
 Easy to Release Dust



0.4L Hand Stick Vacuum Cleaner
450W | 20S



SPECIFICATION

Power (W): 450
Capacity (L): 0.4
Cord Length: 5 M
Product Dimension (WxDxH):
 200x250x1100 mm
Package Dimension (WxDxH):
 130x205x655 mm
Net Weight (Kg): 1.9
Gross Weight (Kg): 2.7

KEY FEATURES

2-in-1 Design
 Multi-Cleaning
 Stick & Hand Held
 Transparent Dust Cup
 Easy to Release Dust



23L Drum Vacuum Cleaner
2200W | MDVC23



SPECIFICATION

Power (W): 2200
Capacity (L): 23
Cord Length: 5 M
Product Dimension (WxDxH):
 376x336x507 mm
Package Dimension (WxDxH):
 400x385x500 mm
Net Weight (Kg): 6.2
Gross Weight (Kg): 9

KEY FEATURES

Ultra Large Capacity
 Blow Function
 Easy Empty Drum
 Crevice Tool and
 Dust Brush on Board
 Adjustable Tube
 Crevice Nozzle x1
 Round Brush x1
 Powerful Motor Delivery
 Strong Suction



21L Drum Vacuum Cleaner
2000W | MDVC21



SPECIFICATION

Power (W): 2000
Capacity (L): 21
Cord Length: 5 M
Product Dimension (WxDxH):
 376x336x507 mm
Package Dimension (WxDxH):
 400x385x500 mm
Net Weight (Kg): 6.2
Gross Weight (Kg): 8.2

KEY FEATURES

Ultra Large Capacity
 Blow Function
 Easy Empty Drum
 Crevice Tool and
 Dust Brush on Board
 Adjustable Tube
 Crevice Nozzle x1
 Round Brush x1
 Powerful Motor Delivery
 Strong Suction



18L Drum Vacuum Cleaner
1800W | MDVC18



SPECIFICATION

Power (W): 1800
Capacity (L): 18
Cord Length: 5 M
Product Dimension (W×D×H):
 376×336×507 mm
Package Dimension (W×D×H):
 400×385×500 mm
Net Weight (Kg): 6.2
Gross Weight (Kg): 7.85

KEY FEATURES

Ultra Large Capacity
 Blow Function
 Easy Empty Drum
 Crevice Tool and
 Dust Brush on Board
 Adjustable Tube
 Crevice Nozzle x1
 Round Brush x1
 Powerful Motor Delivery
 Strong Suction



2L Canister Vacuum Cleaner
1800W | MC08MEWH



SPECIFICATION

Power (W): 1800
Capacity (L): 2
Cord Length: 5 M
Product Dimension (W×D×H):
 363×247×294 mm
Net Weight (Kg): 4.65
Gross Weight (Kg): 5.25

KEY FEATURES

Automatic Cable Winding
 Compact and Lightweight
 Easy Carrying
 Large Dustbin, Easy Emptying
 Cyclone System



2L Canister Vacuum Cleaner
1800W | MC08MEBU



SPECIFICATION

Power (W): 1800
Capacity (L): 2
Cord Length: 6 M
Product Dimension (W×D×H):
 363×247×294 mm
Net Weight (Kg): 4.65
Gross Weight (Kg): 5.25

KEY FEATURES

Automatic Cable Winding
 Compact and Lightweight
 Easy Carrying
 Crevice Tool
 Large Dustbin, Easy Emptying
 Cyclone System



0.8L Stick Vacuum Cleaner
600W | SC861



SPECIFICATION

Power (W): 600
Capacity (L): 0.8
Cord Length: 5 M
Product Dimension (W×D×H):
 254×136×1100 mm
Package Dimension (W×D×H):
 115×135×680 mm
Net Weight (Kg): 1.75
Gross Weight (Kg): 2.8

KEY FEATURES

2-in-1 Design
 Multi Cleaning
 Crevice Tool
 Efficient Noise Reduction
 Powerful "Heart" from
 Endurable Motor
 5-Meter Power Cord
 Cleaning without Unplugging
 High-Quality Motor





*Make room
for fresher
air*

AIR TREATMENT



Designed to keep your home comfortable in every season, Midea's Air Treatment delivers refreshing airflow and cozy warmth whenever you need it. With efficient performance, thoughtful design, and easy operation, these solutions help create the ideal indoor environment for everyday living.

AC100-18B

Air Cooler MAC-100MOBPHV



SPECIFICATION

Voltage/Power: 420W
Capacity: 100L
Certification: CB
Product Dimension (WxDxH):
 718x448x1320 mm
Package Dimension (WxDxH):
 770x510x1365 mm
Weight (Net/Gross) Kg: 24.9/30.2
QTY/CTN: 1
Loading QTY
(20'GP/40'GP/40'HQ):
 49/102/117
Market: UAE + GCC

KEY FEATURES

420W Air Cooler
 Mist Function with 100L
 Water Tank (Max Water Line 80L)
 Air Volume up to 4000m³/h
 Humidifying Capacity
 up to 7000ml/h
 Negative Ion Technology
 Available
 Mechanical Control
 3 Speed Setting



Air Cooler AC200-17JR



SPECIFICATION

Voltage/Power:
 220-240V/50/60Hz 200W
Capacity: 50L
Certification: CE/CB/GCC
Product Dimension (WxDxH):
 390x460x1080 mm
Package Dimension (WxDxH):
 520x455x818 mm
Weight (Net/Gross) Kg: 14.2/16.4
QTY/CTN: 1
Loading QTY
(20'GP/40'GP/40'HQ):
 132/274/312
Market: Kuwait, Oman, Qatar,
 UAE & Bahrain

KEY FEATURES

Humidifying Function
 Built-in Ion Generator
 3 Speed Levels
 Wide Angle Internal Oscillation
 Auto Shut Pump Protection
 Starts When Waterless
 12 Hour Programmed Timer
 Automatically Close Front Grille
 Prevents Dust Getting in



Air Cooler AC360-20A



SPECIFICATION

Voltage/Power:
 150W
Capacity: 32L
Certification: CB
Product Dimension (WxDxH):
 514x366x950 mm
Package Dimension (WxDxH):
 555x380x1010 mm
Weight (Net/Gross) Kg: 9.5/12.7
QTY/CTN: 1
Loading QTY
(20'GP/40'GP/40'HQ):
 132/276/322
Market: UAE+GCC

KEY FEATURES

Humidifying Function with 32L
 Water Tank (Max water line 23L)
 Air Volume up to 1500m³/h
 Mechanical Control
 3 Speed Setting
 Filling Water from the Top &
 Bottom are Available
 Oscillation Function to
 Ensure Comfort Cooling
 for Every Corner



Air Cooler AC120-15C



SPECIFICATION

Voltage/Power: CB 60W
Capacity: 7L
Certification: CB
Product Dimension (W×D×H):
 495×368×860 mm
Package Dimension (W×DXH):
 495×368×860 mm
Weight (Net/Gross) Kg: 9.2/11.3
QTY/CTN: 1
Loading QTY
(20'GP/40'GP/40'HQ):
 230/500/600
Market: UAE + GCC

KEY FEATURES

Humidifying function
 3 Speed Levels
 2 Wind Modes
 7-Hour Timer
 Remote Control
 Low Water Indicator



3 Speed Levels



7-Hours Timer



Humidifying Function

Air Cooler AC200-W



SPECIFICATION

Voltage/Power:
 100W
Capacity: 7L
Certification: CB
Product Dimension (W×D×H):
 467×407×1020 mm
Package Dimension (W×DXH):
 467×407×1020 mm
Weight (Net/Gross) Kg: 11.4/14.3
QTY/CTN: 1
Loading QTY
(20'GP/40'GP/40'HQ):
 165/330/372
Market: UAE+GCC

KEY FEATURES

Humidifying Function
 Built-in Ion Generator
 3 Speed Levels
 Wide Angle Internal Oscillation
 Auto Shut Pump Protection
 Starts When Waterless
 12-Hour Timer
 Automatically Close Front
 Grille Prevents Dust Getting in



3 Speed Levels



12-Hours Timer



Humidifying Function

Air Cooler AC200-W



SPECIFICATION

Voltage/Power:
 220-240V/50/60Hz 100W
Capacity: 7L
Certification: CE/CB/GCC
Product Dimension (W×D×H):
 400×328×970 mm
Package Dimension (W×D×H):
 467×407×1020 mm
Weight (Net/Gross) Kg: 11.4/14.3
QTY/CTN: 1
Loading QTY
(20'GP/40'GP/40'HQ):
 165/330/372
Market: Kuwait, Oman, Qatar,
 UAE & Bahrain

KEY FEATURES

Humidifying Function
 Built-in Ion Generator
 3 Speed Levels
 Wide Angle Internal Oscillation
 Auto Shut Pump Protection
 Starts When Waterless
 12 Hour Timer
 Automatically Close Front Grille
 Prevents Dust Getting in



3 Speed Levels



12-Hours Timer



Humidifying Function

Air Cooler AC100-18B



SPECIFICATION

Voltage/Power:
CB 50W
Capacity: 4.8L
Certification: CB
Product Dimension (W×D×H):
400×328×970 mm
Package Dimension (W×D×H):
467×407×1020 mm
Weight (Net/Gross) Kg: 6/8.8
QTY/CTN: 1
Loading QTY
(20'GP/40'GP/40'HQ):
288/600/690
Market: UAE + GCC

KEY FEATURES

Left-Right Internal Oscillation
Easy-Moving Feet
3 Speed Levels



3 Speed Levels



Left-Right Internal Oscillation



Easy Moving

Box Fan FB50-17H



SPECIFICATION

Voltage/Power:
220-240V 50Hz 50W
Certification: CB
Product Dimension (W×D×H):
561x180x613 mm
Package Dimension (W×D×H):
627x152x610 mm
Weight (Net/Gross) Kg: 4.1/3.3
QTY/CTN: 1
Loading QTY
(20'GP/40'GP/40'HQ):
459/960/1090
Market: UAE + GCC

KEY FEATURES

3 Speed Levels
18 Inch Design
Oscillation Function brings
Wider Range of Air Flow
Direction



3 Speed Levels



Oscillation Function



Wider Range of Air Flow

Stand Fan FS40-25JA



SPECIFICATION

Voltage/Power:
40W
Certification: CB/GCC
Product Dimension (W×D×H):
453x396x(1075-1200) mm
Package Dimension (W×D×H):
504x148x594 mm
Weight (Net/Gross) Kg: 5.6/7.0
QTY/CTN: 1
Loading QTY
(20'GP/40'GP/40'HQ):
600/1290/1397
Market: UAE + GCC

KEY FEATURES

5 Blades
3 Speed Levels
70° Oscillation Function brings
Wider Range of Air Flow
Direction
20° Variable Tilt Fan Head,
Manual Control
High Quality AC Copper Motor



3 Speed Levels



5 Blades



Wider Range of Air Flow

Stand Fan
FS40-25JRA



SPECIFICATION

Voltage/Power:
40W
Certification: CB/GCC
Product Dimension (W×D×H):
453x396x(1075-1200) mm
Package Dimension (W×D×H):
504x148x594 mm
Weight (Net/Gross) Kg: 6.2/8.02
QTY/CTN: 1
Loading QTY
(20'GP/40'GP/40'HQ):
600/1290/1397
Market: UAE + GCC

KEY FEATURES

5 Blades
 3 Speed Levels
 6H Timer
 70° Oscillation Function brings
 Wider Range of Air Flow
 Direction
 20° Variable Tilt Fan Head.
 Manual Control
 High Quality AC Copper Motor



3 Speed Levels



Remote Control



Wide Range of Air Flow

Stand Fan
MFS-160M0BPW



SPECIFICATION

Voltage/Power: 40W
Certification: CB
Product Dimension (W×D×H):
700×700×1200 mm
Package Dimension (W×D×H):
421×105×563 mm
Weight (Net/Gross) Kg: 2.85/3.4
QTY/CTN: 1
Loading QTY
(20'GP/40'GP/40'HQ):
1040/2150/2420
Market: UAE + GCC

KEY FEATURES

3 Speeds
 Oscillation Function Brings
 Wider range of Air Flow
 Direction
 High Quality Copper Motor
 (Aluminum Motor)
 Adjustable Height
 Round Base
 Line Grill



3 Speed Levels



Oscillation Function



Wide Range of Air Flow

Stand Fan
FS45-23MRD



SPECIFICATION

Voltage/Power:
220-240V,50Hz,55W
Certification: CB
Product Dimension (W×D×H):
454×400×1300 mm
Package Dimension (W×D×H):
537×142×591 mm
Weight (Net/Gross) Kg: 6.1/6.9
Loading QTY
(20'GP/40'GP/40'HQ):
600/1210/1390
Market: Kuwait, Oman, Qatar,
 UAE & Bahrain

KEY FEATURES

9 Speed Levels
 5 Blades for Chill-Cool
 Experience
 80° Oscillation for
 Wider Air Flow
 High Quality Copper Motor
 Battery Run Time Up to 11 Hours
 Blade: 16"
 Built-in Rechargeable Battery
 Supports Cordless Use



9 Speed Levels



5 Blades



High Quality AC Copper

Ceiling Fan DS56 (56In.)



SPECIFICATION

Voltage/Power: 75W
Certification: CB
Package Dimension (W×D×H):
 765×315×215 mm
Weight (Net/Gross) Kg: 14/15
QTY/CTN: 1
Loading QTY
(20'GP/40'GP/40'HQ):
 1890/3024/4320
Market: Oman

KEY FEATURES

3 Blades (Material: Iron)
 5 Speed Settings
 Cut-off Safety Device
 Ball Bearing Motor for
 Extra Durability
 Safety Lock
 Air Volume: 230m³/min



5 Speed Levels



Safety Lock



3 Blades

Tower Fan FZ10-18TRB



SPECIFICATION

Voltage/Power:
 220-240V,50Hz,50W
Certification: CB/GCC
Product Dimension (W×D×H):
 300×300×1013 mm
Package Dimension (W×D×H):
 1058×223×199 mm
Weight (Net/Gross) Kg: 4.5/5.8
QTY/CTN: 1
Loading QTY
(20'GP/40'GP/40'HQ):
 574/1210/1440
Market: UAE + GCC

KEY FEATURES

3 Wind Modes
 High Quality Copper Motor
 Adjustable Height
 Blade: 16"
 Wide Angle Internal Oscillation
 Multifunction Remote Control
 Sleep Mode
 Natural Mode
 Internal Oscillation



Multifunction Remote Control



Sleep Mode



3 Wind Modes

Tower Fan MFZ-100ROBPK



SPECIFICATION

Voltage/Power:
 220-240V,50Hz,45W
Certification: CB
Product Dimension (W×D×H):
 330×330×1013 mm
Package Dimension (W×D×H):
 230×209×1058 mm
Weight (Net/Gross) Kg: 3.7/4.7
QTY/CTN: 1
Loading QTY
(20'GP/40'GP/40'HQ):
 495/997/1180
Market: UAE + GCC

KEY FEATURES

3 Wind Modes
 Wide Angle Internal Oscillation
 Multifunction Remote Control
 Innovative Built-in Fragrant Box
 5 Speed Control
 Smart Wind
 Internal Oscillation
 Quiet Operation



5 Speed Levels



Multifunction Remote Control



3 Wind Modes

Oil Filled Heater

NY2009-20M / NY2311-22HF / NY2513-22HF



SPECIFICATION

Voltage/Power:

220-240V, 50Hz, 2000 /
220-240V, 50Hz, 2700W /
220-240V, 50Hz, 2900W

Capacity: 9/11/13 FINS

Certification: CB

Product Dimension (W×D×H):
393×280×640 / 390×226×570 /
450×226×570 mm

Package Dimension (W×D×H) mm:
483×143×665 / 465×167×660 / 524×167×660

Weight (Net/Gross) Kg:

9.7 / 9.9 / 11.4 Kg

Loading QTY

(20'GP/40'GP/40'HQ):

584X1220X1438

Market: Kuwait



23 Heating Levels



2 Adjustable Thermostat



Over Heating Protector

KEY FEATURES

Simple but Elegant Design
23 Heating Levels
2000W Capacity
2 Adjustable Thermostat
Top-Over Switch Protection
Over Heating Protection

Oil Filled Heater

NY2009-22HF / NY2311-22HF / NY2513-22HF



SPECIFICATION

Voltage/Power:

220-240V, 50Hz, 2400W /
220-240V, 50Hz, 2700W /
220-240V, 50Hz, 2900W

Certification: CB/GCC

Product Dimension (W×D×H):
330×226×570 / 390×226×570 /
450×226×570 mm

Package Dimension (W×D×H):
406×167×660 / 465×167×660 /
524×167×660 mm

Weight (Net/Gross) Kg:

8.4 / 9.9 / 11.4 Kg

QTY/CTN: 1

Market: Kuwait



3 Heat Settings



Manual Control



Handle

KEY FEATURES

New U Shape Fins Design
for Quiet & Better Performance
3 Heat Settings with
Thermostat Setting
Convenient Cord Storage
& Casters
Overheat & Tip-over Protection
Built-in Handle
Manual Control

Fan Heater

NF20-18UR



SPECIFICATION

Voltage/Power:

220-240V, 50Hz, 2000W

Certification: CB/GCC

Product Dimension (W×D×H):
260x189x265 mm

Package Dimension (W×D×H):
409x279x323 mm

Weight (Net/Gross) Kg: 1.82kg / 2.1kg

QTY/CTN: 2

Loading

QTY (20'GP/40'GP/40'HQ):

1568/3206/3664

Market: Kuwait



Over Heating Protector



3 Heating Levels



Handle

KEY FEATURES

Overheat & Tip-over
Protection
Easier to Move and
Carry with Handle Design
Temperature Setting
4 Heating Levels
More Choices for Warming
Experience

Fan Heater NTH20-22ER



SPECIFICATION

Voltage/Power:
220-240V, 50Hz, 2000W
Certification: CB/GCC
Product Dimension (WxDxH):
178x180x582 mm
Package Dimension (WxDxH):
207x207x641 mm
Weight (Net/Gross) Kg: .25/2.6 Kg
QTY/CTN: 1
Market: Kuwait

KEY FEATURES

Slender Size Higher Performance
Even Heating With 65-75° Oscillation
Digital Thermostat with LED Display
Touch Control on Top
Overheat & Tip-Over Protection
ECO Mode Setting
24-Hour Timer
3 Settings (High, Low & Fan only)



LED Display



Over Heating Protector



24-Hours Timer

Fan Heater NTY20-22E



SPECIFICATION

Voltage/Power:
220-240V, 50Hz, 2000W
Certification: CB/GCC
Product Dimension (WxDxH):
170x124x278 mm
Package Dimension (WxDxH):
177x131x284 mm
Weight (Net/Gross) Kg: 1.43/1.6 Kg
QTY/CTN: 1
Market: Kuwait

KEY FEATURES

High-low Settings with Thermostat Control Function
Wide Range Oscillation 40±5°
Switch Control on Front-Side
Overheat & Tip-Over Protection



High-Low Settings



Wide Range Oscillation



Over Heating Protector



*Make room
for more
flavor*

SMALL APPLIANCES



MAD-110D2APK

Midea's Small Appliances simplify your daily routines by adding convenience to every day cooking. From quick breakfast to effortless prep, each appliance combines smart functionality, compact design, and reliable performance to help you serve with ease, making every kitchen moment smoother and more enjoyable.

Air Fryer
MAD-110D2APK



SPECIFICATION

Voltage/Power:
220-240V / 2200W
Capacity: 11L
Certification: CB
Product Dimension (WxDxH):
430x326x405 mm
Package Dimension (WxDxH):
480x380x470 mm
Weight (Net/Gross) Kg: 6.2/71
Loading QTY (40'HQ): 810
Market: Kuwait, Oman, Qatar,
UAE & Bahrain

KEY FEATURES

With Two-Zone Design,
Cooking 2 Foods at Once
Large See-through Window
with Internal Light
10 Preset Menus for
Numerous Dishes
1 to 90 Mins Timer Range
Wide Temperature Range:
40°C to 230°C
Overheat Protection



Wide
Temperature
Range



1 to 90 Mins
Timer Range



Overheat
Protection

Air Fryer
MAD-900F2BPK



SPECIFICATION

Voltage/Power:
220-240V / 1800W
Capacity: 9L
Certification: CB
Product Dimension (WxDxH):
343x464x293 mm
Package Dimension (WxDxH):
485x375x331 mm
Weight (Net/Gross) Kg: 6.2/7.1
Loading QTY (20'GP/40'GP/40'HQ):
504/1036/1184
Market: Kuwait, Oman, Qatar,
UAE & Bahrain

KEY FEATURES

HeatXpress Technology
Even Cooking
1 to 60 Mins Timer Range
10 Preset Menus for
Numerous Dishes
Wide Temperature Range:
40°C to 230°C
Auto-Pause when Basket
is Removed
No-Flip Approach



Overheat
Protection



Wide
Temperature
Range



Dishwasher
Safe



Portable Digital
Touch Control

Air Fryer
MF-CY70K



SPECIFICATION

Voltage/Power:
220-240V / 1500-1800W
Capacity: 7L
Certification: CB
Product Dimension (WxDxH):
344x271x343 mm
Package Dimension (WxDxH):
411x318x409 mm
Weight (Net/Gross) Kg: 4.9/5.73
Loading QTY (20'GP/40'GP/40'HQ):
510/1055/1266
Market: UAE + GCC

KEY FEATURES

Operation Upgrade with
Digital Touch Control,
One Touch Start
HeatXpress Technology
Even Cooking
See-Through Window
4 Modes: Keep Warm,
DIY, +1 Min
Wide Temperature Range:
40°C to 200°C
1 to 60 Mins Timer Range
Easy Cleaning with
Non-Stick Coating



Digital
Touch Control



Wide
Temperature
Range



1 to 60 Mins
Timer Range

Air Fryer
MAD-600F2BPK



SPECIFICATION

Voltage/Power:
 220-240V / 1700W
Capacity: 6L
Certification: CB
Product Dimension (W×D×H):
 310×400×310 mm
Package Dimension (W×D×H):
 274×273×358 mm
Weight (Net/Gross) Kg: 4.5/5.4
Loading QTY
(20'GP/40'GP/40'HQ):
 455/945/1080
Market: Kuwait, Oman, Qatar,
 UAE & Bahrain

KEY FEATURES

7 Presets for Versatile Uses
 1 to 60 Mins Timer Range
 Wide Temperature Range:
 40°C to 230°C
 Auto-Pause
 when Basket is Removed
 Overheat Protection



1 to 60 Mins
 Timer Range



Wide
 Temperature
 Range



Digital
 Touch Control



One Touch
 Start



Overheat
 Protection

Air Fryer
MAD-550F2APK



SPECIFICATION

Voltage/Power:
 220-240V / 1600W
Capacity: 5L
Certification: CB
Product Dimension (W×D×H):
 344×271×300 mm
Package Dimension (W×D×H):
 411×318×365 mm
Weight (Net/Gross) Kg: 4.47/5.2
Loading QTY
(20'GP/40'GP/40'HQ):
 612/1266/1477
Market: Kuwait, Oman, Qatar,
 UAE & Bahrain

KEY FEATURES

See-Through Window
 7 Presets for Versatile Uses
 4 Modes: Keep Warm,
 DIY, +1 min
 1 to 60 Mins Timer Range
 Wide Temperature Range:
 40°C to 200°C
 Auto-Pause when Basket
 is Removed



1 to 60 Mins
 Timer Range



Wide
 Temperature
 Range



Digital
 Touch Control



One Touch
 Start

Air Fryer
MAD-450F2BPK



SPECIFICATION

Voltage/Power:
 220-240V / 1500W
Capacity: 4.5L
Certification: CB
Product Dimension (W×D×H):
 374×282×279 mm
Package Dimension (W×D×H):
 320×400×350 mm
Weight (Net/Gross) Kg: 4.22/4.9
Loading QTY
(20'GP/40'GP/40'HQ):
 588/1218/1421
Market: Kuwait, Oman, Qatar,
 UAE & Bahrain

KEY FEATURES

7 Presets for Versatile Uses
 1 to 60 Mins Timer Range
 Wide Temperature Range:
 40°C to 230°C
 Auto-Pause when Basket
 is Removed
 Overheat Protection



1 to 60 Mins
 Timer Range



Wide
 Temperature
 Range



Digital
 Touch Control



One Touch
 Start



Overheat
 Protection

SUS Toaster
MT-RW2L20W



SPECIFICATION

Voltage/Power:
 220-240V/850-950W
Capacity: L130 Slot
Certification: ROHS LFGB
Product Dimension (W×D×H):
 260x166x187 mm
Package Dimension (W×D×H):
 316x202x220 mm
Weight (Net/Gross) Kg: 1.72/6.98
Loading QTY
(20'GP/40'GP/40'HQ):
 1836/3888/4748
QTY/CTN: 4
Market: UAE + GCC

KEY FEATURES

Auto-Adjusting for Even Browning
 Auto Power Cut Off Function
 Removable Crumb Tray
 Anti-Slip Feet Design
 Cord Storage



Cord Storage



Auto Power Cut Off



Anti-Slip Feet Design

Multicooker
MY-GPC1001



SPECIFICATION

Voltage/Power:
 220V/1500W
Capacity: 10L
Certification: CE/CB
Product Dimension (W×D×H):
 392×420×375 mm
Package Dimension (W×D×H):
 445×420×428 mm
Weight (Net/Gross) Kg: 9.1/10.6
Loading QTY
(20'GP/40'GP/40'HQ):
 325/675/675
Market: UAE + GCC

KEY FEATURES

Large Control Box and LED Display
 Multi-Function, 7 Preset Menu
 1 Touch Kick-Starts
 24-Hours Preset Timer
 Keep Warm/Cancel Function
 9 Safety Guard
 Dishwasher Safe
 Stainless Steel Inner Pot
 40/80kpa Dual Pressure Levels
 Local Menu



Large Control Box



24 Hours Preset Timer



Dishwasher Safe

Multicooker
MPC-8002SBSS-NPR



SPECIFICATION

Voltage/Power:
 220-240V 50Hz /1200W
Capacity: 8L
Certification: CB
Product Dimension (W×D×H):
 338×369×355 mm
Package Dimension (W×D×H):
 380×380×430 mm
Weight (Net/Gross) Kg: 7.2/8.8
Loading QTY
(20'GP/40'GP/40'HQ):
 450X930X1116
Market: Kuwait, Oman, Qatar, UAE & Bahrain

KEY FEATURES

Two-Side Painted Aluminum Inner Pot
 4-Digit LED Display
 Pressure Indicator
 Special Lid Location Design
 24-Hours Preset Timer
 Multi-Function 20 Preset Menu
 9 Safety Mechanism
 Local Menu



4-Digit LED Display



24 Hours Preset Timer



9 Safety Mechanism

Multicooker

MPC-6002SBSS-NPR



SPECIFICATION

Voltage/Power:
220-240V 50/60Hz /1000W
Capacity: 6L
Certification: CB
Product Dimension (W×D×H):
330×310×337 mm
Package Dimension (W×D×H):
358×358×395 mm
Weight (Net/Gross) Kg: 4.4/5.8
Loading QTY
(20'GP/40'GP/40'HQ):
480/960/1152
Market: Kuwait, Oman, Qatar,
UAE & Bahrain

KEY FEATURES

Stainless Steel Housing
SUS 430 Inner Lid
Food Grade Silicone Seal Ring
Pressure Indicator Showing
the Pressure Status
Multi-Function, More than
8 Preset Menu (Up to 15)
24-Hours Preset Timer
9 Safety Mechanism



4-Digit
LED Display



24 Hours
Preset Timer



Large Control
Box

Kettle

MK-HJ1705G



SPECIFICATION

Voltage/Power:
220-240V/50/60Hz / 1850-2200W
Capacity: 1.7L
Certification: CB
Product Dimension (W×D×H):
214×153×252 mm
Package Dimension (W×D×H):
596×250×570 mm
Weight (Net/Gross) Kg: 1.0/1.4
Loading QTY
(20'GP/40'GP/40'HQ):
2094/4326/4668
Market: Kuwait, Oman, Qatar,
UAE & Bahrain

KEY FEATURES

Double Layer Housing
Brushed Stainless Steel Body
Big Water Window
360° Base
0.3L Minimum Environmental
Boiler
Push Open Button



360°
Base



Double Layer
Housing



Brushed
Stainless Steel
Body

Kettle

MK-17S32A2



SPECIFICATION

Voltage/Power:
220-240V/50/60Hz / 1850-2200W
Capacity: 1.7L
Certification: CB
Product Dimension (W×D×H):
220×150×245 mm
Package Dimension (W×D×H):
556×417×242 mm
Weight (Net/Gross) Kg: 0.8/1.0
Loading QTY
(20'GP/40'GP/40'HQ):
3120/6564/7458
Market: UAE

KEY FEATURES

1.7L Capacity
Brushed 304 Stainless Steel Body
360° Base
Convenient Cordless Kettle
Pop-up Lid



360°
Base



Brushed
Stainless Steel
Body



Pop-up
Lid

Kettle

MK-17S40A2



SPECIFICATION

Voltage/Power:
CB 2200W
Capacity: 1.7L
Certification: CB
Product Dimension (W×D×H):
215×150×240 mm
Package Dimension (W×D×H):
558×433×264 mm
Weight (Net/Gross) Kg: 1.2/1.6
Loading QTY
(20'GP/40'GP/40'HQ):
2688/5592/6240
Market: UAE + GCC

KEY FEATURES

Brushed Stainless Steel Body
Water Level Gauge
360° Base
0.3L Minimum
Environmental Boiler
Convenient Cordless Kettle



360° Base



Brushed
Stainless Steel
Body



360° Base

Kettle

MK-SH15



SPECIFICATION

Voltage/Power:
220-240V/1500-1800W
Capacity: 1.5L
Certification: GS, LVD, CB, LFGB
RoHS&REACH
Product Dimension (W×D×H):
221×155×241 mm
Package Dimension (W×D×H):
646×453×261 mm
Loading QTY
(20'GP/40'GP/40'HQ):
2160/4368/5454
Market: UAE + GCC

KEY FEATURES

1.5L Capacity
Stainless Steel Inside & Plastic
Outside For Cold-Touch
360° Base
Automatic Pop-Up Lid
Convenient Cordless Kettle
Plastic Base and Lid



360° Base



1.5L Capacity



Pop-up
Lid

Kettle

MK-SH15X301A2



SPECIFICATION

Voltage/Power:
220-240V/1850-2200W
Capacity: 1.5L
Certification: ROHS LFGB
Product Dimension (W×D×H):
227×155×255 mm
Package Dimension (W×D×H):
621×246×573 mm
Weight (Net/Gross) Kg: 1.31/1.55
Loading QTY
(20'GP/40'GP/40'HQ):
1962/4098/4464
Market: UAE + GCC

KEY FEATURES

1.5L Capacity
Stainless Steel Inside & Plastic
Outside For Cold-Touch
Different Temperature Options
360° Base
Automatic Pop-Up Lid
Convenient Cordless Kettle
Plastic Base and Lid



360° Base



1.5L Capacity



Pop-up
Lid

Table Blender
MJ-BL5001AW



SPECIFICATION

Voltage/Power:
220-240V, 50/60Hz /
CB: 1000W / GCC 900W
Capacity: 1.5L
Certification: CB
Product Dimension (WxDxH):
207x200x416 mm
Package Dimension (WxDxH):
457x287x424 mm
Weight (Net/Gross) Kg: 4.1/4.8
Loading QTY
(20'GP/40'GP/40'HQ):
1000/2220/2496
Market: Kuwait, Oman, Qatar,
UAE & Bahrain

KEY FEATURES

1.5L Blender Cup
6 Blade in Two Layers
Removable, Dishwasher Safe
Variable Speed Control with
Illuminated Display
Three Separate Button, Pulse,
Ice Crush, Smoothie
Stainless Steel Housing



Dishwasher
Safe



1.5 Blender
Cup



6 Leaves Blade
in Two Layers

Table Blender
BL2516AG



SPECIFICATION

Voltage/Power:
220-240V, 50/60Hz /
CB: 350W / GCC 350W
Capacity: 1.5L Jar + 200 ml Jar
Certification: CB
Product Dimension (WxDxH):
162x192x354 mm
Package Dimension (WxDxH):
748x380x406 mm
Weight (Net/Gross) Kg: 1.5/1.9
Loading QTY
(20'GP/40'GP/40'HQ):
2136/4560/4608
Market: Kuwait, Oman, Qatar,
UAE & Bahrain

KEY FEATURES

Two Speeds with
Pulse Function
Interlock Protection
4 Leaves SUS 301 Blade
with 2 Layers
Food Grade Material Blade
Detachable Blade for
Easy Cleaning
BPA-Free
Anti-Slip Suction Feet
200ml Grinder



Interlock
Protection



Food Grade
Material Blade



4 Leaves Blade
in Two Layers

Table Blender
MJ-BL6014W



SPECIFICATION

Voltage/Power:
220-240V,
600W / 350W
Capacity: 1.5L
Certification: CB
Product Dimension (WxDxH):
158x170x390 mm
Package Dimension (WxDxH):
224x173x400 mm
Weight (Net/Gross) Kg: 2.72/3.1
Loading QTY
(20'GP/40'GP/40'HQ):
1816/3764/4444
Market: UAE

KEY FEATURES

1.5L Glass Jar
76 Series Motor
Button/Spin Control
4 Leaves SUS 301 Blade
with 2 Layers
Three Speeds with
Pulse Function
Interlock Protection
Food Grade Material Blade
Detachable Blade
for Easy Cleaning



Interlock
Protection



4 Leaves Blade
in Two Layers



1.5L Glass
Jar

Table Blender
MJ-BL1010W



SPECIFICATION

Voltage/Power:
220-240V
Capacity: 1.5L
Certification: CB
Product Dimension (W×D×H):
158×58×180 mm
Package Dimension (W×D×H):
374×216×247 mm
Weight (Net/Gross) Kg: 3.14/3.63
Loading QTY
(20'GP/40'GP/40'HQ):
1232/2468/2864
Market: UAE

KEY FEATURES

1.5L Glass
60ml Measuring Cup
5 Speeds with Pulse Function
Ice Crush Function
Interlock Protection
6 Leaves SUS 301 Blade
with 2 Layers
Detachable Blade
for Easy Cleaning
Portable Handle Design
Dishwasher Safe
BPA-Free



Interlock Protection



1.5L Glass Jar



6 Leaves Blade in Two Layers

Table Blender
MJ-BL2518A-1



SPECIFICATION

Voltage/Power:
220-240V
Capacity: 1.5L
Certification: CB
Product Dimension (W×D×H):
194×164×380 mm
Package Dimension (W×D×H):
182×182×412 mm
Weight (Net/Gross):
1.62 Kg / 1.9 Kg
Loading QTY
(20'GP/40'GP/40'HQ):
1800/3720/4432
Market: GCC, Levant

KEY FEATURES

1.25L SAN Jar + 200ml SAN
Grinder Jar
50ml Measuring Cup
Two Speeds with
Pulse Function
Interlock Protection
4 Leaves SUS 301 Blade
with 2 Layers
Food Grade Material Blade
Detachable Blade for
Easy Cleaning
BPA-Free



Dishwasher Safe



Food Grade Material Blade



4 Leaves Blade in Two Layers

Table Blender
BL7001AW



SPECIFICATION

Capacity: 1.5L
Certification: CB
Product Dimension (W×D×H):
220×185×401 mm
Package Dimension (W×D×H):
412×341×259 mm
Weight (Net/Gross):
3.5 Kg / 3.9 Kg
Loading QTY
(20'GP/40'GP/40'HQ):
1728/3456/3840

KEY FEATURES

Compact Design
1.5L Glass Jar
Pulse + 2 Speeds
Off-Center High
Performance Blade Tech
Safety Lock



1.5L Glass Jar



Safety Lock



High Performance Blade



*Make room
for perfectly brewed
moments*

COFFEE MACHINES

Our Coffee Machines brings the flavors of your favorite café right to your home. With intuitive features, consistent brewing performance, and sleek, modern design, they make it easy to enjoy perfectly brewed cups whenever you need them. Because great days start with great coffee.

MCA-15B0FADMCPK



Fully Automatic Coffee Machine
MCA-15B0FADMCPK



SPECIFICATION

Water Tank Capacity: 2L
Coffee Bean Container: 250g
Product Dimension (W×D×H):
 467×220×369 mm
Package Dimension (W×D×H):
 544×288×425 mm
Net Weight (Kg): 9.8
Gross Weight (Kg): 12.9
Pressure: 15bar
Voltage/Power: 220-240V
Frequency: 50/60Hz
Power: 1450-1650W
Market: UAE + GCC

KEY FEATURES

One-Touch to Coffee
 Touch Button Control
 7 Grinder Levels
 10 Beverage Options
 2-Cups Function
 3 Coffee Strength Settings
 4 Water Hardness Settings
 3 Milk Foam Settings



Precise Dosing System



15 Bar Pressure Water Pump



Touch / Push Control



Dual Cream System



2 Cups and Manual Function



Multifunction

Drip Coffee Maker
MA-D1502ME



SPECIFICATION

Water Tank Capacity: 1.5L
Product Dimension (W×D×H):
 280×186×350 mm
Package Dimension (W×D×H):
 286×216×365 mm
Net Weight (Kg): 1.84
Gross Weight (Kg): 2.38
Voltage/Power: 220-240V
Frequency: 50/60Hz
Power: 920-1080W
Market: UAE + GCC

KEY FEATURES

Heating Plate for Warm Keeping
 Stainless Steel Decoration
 Easy-View Water Window
 High-Quality Glass Jar
 Power On/Off Indicator
 Automatic Switch-Off
 Delay Start Function
 Aroma Function
 Digital Control



Aroma Function



Delay Start Function



Heating Plate

Drip Coffee Maker
MA-D1502M



SPECIFICATION

Water tank Capacity: 1.5L
Product Dimension (W×D×H):
 280×186×350 mm
Package Dimension (W×D×H):
 286×216×365 mm
Net Weight (Kg): 1.84
Gross Weight (Kg): 2.38
Voltage/Power: 220-240V
Frequency: 50/60Hz
Power: 920-1080W
Market: UAE + GCC

KEY FEATURES

Heating Plate for Warm Keeping
 Stainless Steel Decoration
 Easy-View Water Window
 High-Quality Glass Jar
 Power On/Off Indicator
 Automatic Switch-Off (Optional)
 Manual Display



Power On/Off Indicator



Automatic Switch Off



Heating Plate

The Midea logo consists of a white circular icon on the left, which is a stylized crescent shape with a vertical line through it, resembling a stylized 'M' or a wave. To the right of this icon, the word "Midea" is written in a bold, white, sans-serif typeface.

make yourself at home