



*\*Visual for reference & illustration purpose only.*

# **MORE GENTLENESS, MORE CARE**

## WASHING MACHINE

# WASHER & DRYER COMBO

WASHING MACHINE



**INVERTER**

**HealthGuard**

Washer  
**10.5kg**

Dryer  
**7.0kg**

**MF310D105WB**

Titanium Grey

- Turbo Foam+
- Auto Dose
- Stain Erase
- OLED Lunar Dial
- 535mm Large Drum
- Smart Control
- BLDC Motor

## UNIQUE FEATURES



### TurboFoam+

Automatically adjusts detergent based on load size and weight. A small amount of water pre-mixes with the detergent to create a high-concentration foam that is evenly sprayed on clothes.



### OLED Lunar Dial

The OLED screen integrates cycle and time into a single display. With a 20% larger display area, operation is intuitive and convenient. Each turn lets you save the art of living through the beauty of laundry.



### Auto Dose

One fill for multiple washes.

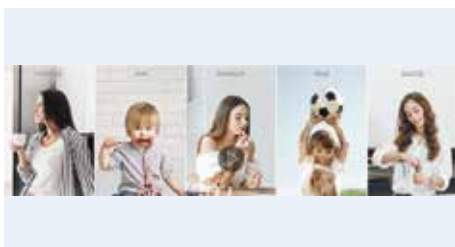

### Stain Erase

The "Stain" function\* adjusts washing temperature and duration to tackle the toughest of stains: Coffee, jam, makeup, mud, and sauce. It breaks down these stains with the ideal water temperature and scrub wash effect, saving time on pre-care and handwashing, no matter the type of stain.



### BLDC Inverter Motor

The BLDC inverter motor minimizes energy loss and component wear, providing significant energy savings and noise reduction without impairing performance.



### Seamless Slot-in

Designed to seamlessly fit into any space, the ultra-thin body maximizes storage and ensures easy, corner-free cleaning with minimal seams.



# WASHER & DRYER COMBO

WASHING MACHINE



**INVERTER**

**HealthGuard**

Washer  
**10.5kg**

Dryer  
**7.0kg**

**MF210D105WB**

Titanium Grey

Washer  
**15.0kg**

Dryer  
**9.0kg**

**MF210D150WB** **NEW**

Titanium Grey

- Power Mix
- Turbo Wash
- LED Lunar Dial
- 535mm Large Drum
- Smart Control
- BLDC Motor

## UNIQUE FEATURES



### Power Mix

Propelled by high-speed water flow, the rapidly spinning impeller thoroughly mixes water with washing powder, generating abundant foam, and having the washing powder fully dissolved.



### HealthGuard

Hot steam penetrates deep into fabric fibers to sanitize clothes and loosen tough stains, ensuring improved hygiene and better cleaning results.



### Turbo Wash

Enhance the efficiency of your laundry process by utilizing the Turbo feature for quicker and more effective cleaning.



### Drum Clean

Strong 90°C hot water flows effectively clean the inner and outer drums. With MSmartHome, users will get regular reminders to run the drum clean program and keep the washing environment clean and healthy.



### BLDC Inverter Motor

The BLDC inverter motor minimizes energy loss and component wear, providing significant energy savings and noise reduction without impairing performance.



### Seamless Slot-in

Designed to seamlessly fit into any space, the ultra-thin body maximizes storage and ensures easy, corner-free cleaning with minimal seams.



# WASHER & DRYER COMBO

WASHING MACHINE

Washer  
**8.5kg**

Dryer  
**6.0kg**

**MF200D85B**

White

Washer  
**8.5kg**

Dryer  
**6.0kg**

**MF200D85WB**

Titanium Grey

Smart Home

- Turbo Wash
- Add Garment
- Stream Care
- 45min Rapid Wash
- Smart Control
- Lunar Dial
- Allergy Care
- Auto Clean
- 90°C Drum Clean
- BLDC Motor



## UNIQUE FEATURES



### Lunar Dial

Inspired from the splendor and purity of luna, we have Lunar Dial as the key element of Midea Laundry Series. Different from traditional knobs, Lunar Dial integrates the functions from both knob and screen display, offering you more direct laundry experience.



### Drum Clean

Manually selected from touch panel, then drum will have 1/3 water in and heated up to 90°C to have drum self-cleaned -- Anti-bacteria and high temperature to kill germ.



### Inverter Quattro

Leads to **70%** energy saving, **10.4%** lower noise and more than 10 years durable lifespan.

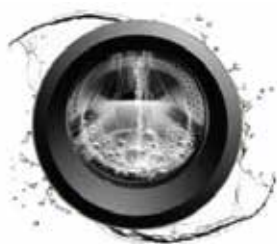

### AUTOCLEAN

Auto Clean cycle will be automatically activated to have inner and outer drum totally cleaned.

(includes programs as Cotton, Mix, Synthetic, Jeans, Cold Wash.)



### Steam Care

Steam Care will have drum heated to develop steam to reach **99.99%\*** Sterilization

(includes programs as Allergy Care and Steam Care)  
• Tested by Vkan Certification & Testing Co., Ltd.



# WASHER & DRYER COMBO

WASHING MACHINE



**INVERTER**

**HealthGuard**

Washer  
**10.0kg**

Dryer  
**7.0kg**

**MF200D100WB**

Titanium Grey

Washer  
**12.0kg**

Dryer  
**8.0kg**

**MF200D120WB**

Titanium Grey

- Turbo Wash
- Lunar Dial
- Allergy Care
- Stream Care
- Auto Clean
- 45min Rapid Wash
- Smart Control
- BLDC Motor
- 90°C Drum Clean

## UNIQUE FEATURES



### Lunar Dial

The knob serves as the control center which integrates the functions of knob and screen together to facilitate your operation. Just focus on the middle of the machine, and select any program and see its information at the same time.



### Auto Clean

For every wash, high-speed water flow will clean dirt and residues on the inner and outer drums to prevent secondary pollution to the clothes.

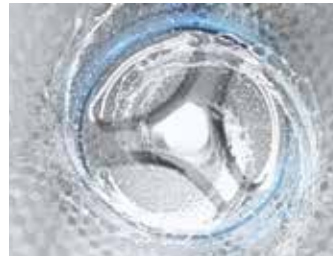

### Drum Clean

Strong 90°C hot water flows effectively clean the inner and outer drums. With MSmartHome, users will get regular reminders to run the drum clean program and keep the washing environment clean and healthy.



### Inverter Quattro

**70%** energy saving  
**10.4%** lower noise  
**10 years** durable life



### Steam Care

The Steam function is activated before main wash, which will generate warm steam to reach 99.99%\* sterilization and greater washing performance.

• Tested by Vkan Certification & Testing Co., Ltd.



### Turbo

Faster and Stronger washing rhythm compared to normal wash. 40% time saving to reach the same washing performance. (Only programs with "icon" added with Turbo)

(Cotton, Mix, Synthetic, Jeans, Bulky)



# LAUNDRY SUITE

## WASHING MACHINE



**HealthGuard**

Washer  
**10.0kg**

Dryer  
**8.0kg**

**ML19F100D80WT-W**  
**ML19F100D80WT-D**

Titanium Grey

- Integrated Central Control
- 115cm Optimal Control Height
- Smart Control
- Heat Pump Dryer
- BLDC Motor

## UNIQUE FEATURES



### Two-in-One Control Panel

Full-colored screen controls washing and drying simultaneously. Clear-cut programs and simplified processes provide hassle-free washing and caring experiences.



115cm  
Optimal Height

### 115cm Operating Height

At 115cm, the belted touchscreen is positioned at eye level, offering comfortable control without the need to raise your shoulders or tiptoe—ideal for users of all height.



### Extra-large Drum

A sleek design with a larger drum provides spacious washing and drying, reducing tangles and enabling easy handling of large items like curtains.



### Fabric Care

Clothing's shape and color, while the average 42°C low-temperature heat pump technology protects the fabric's original texture.



**HealthGuard**

Prioritizing hygiene and health, the antibacterial door seal, five-layer lint filter, and high-temperature sterilization program work together to effectively eliminate bacteria, mites, and lint for enhanced protection.



### Smart Control

Connect your smart devices to SmartHome APP, and easily control and enjoy the moment of free laundry whenever and wherever you are. Just unlock your favourite laundry program on your smart device and enjoy unlimited laundry possibilities.



### BLDC Inverter Motor

The BLDC inverter motor minimizes energy loss and component wear, providing significant energy savings and noise reduction without impairing performance.



### Seamless Design

600mm slim body perfectly matches the cabinet, saving your precious house space. 5mm micro-seam installation, narrower than regular built-in design, and adaptable layout for a more pleasing visual.



# FRONT LOAD

WASHING MACHINE

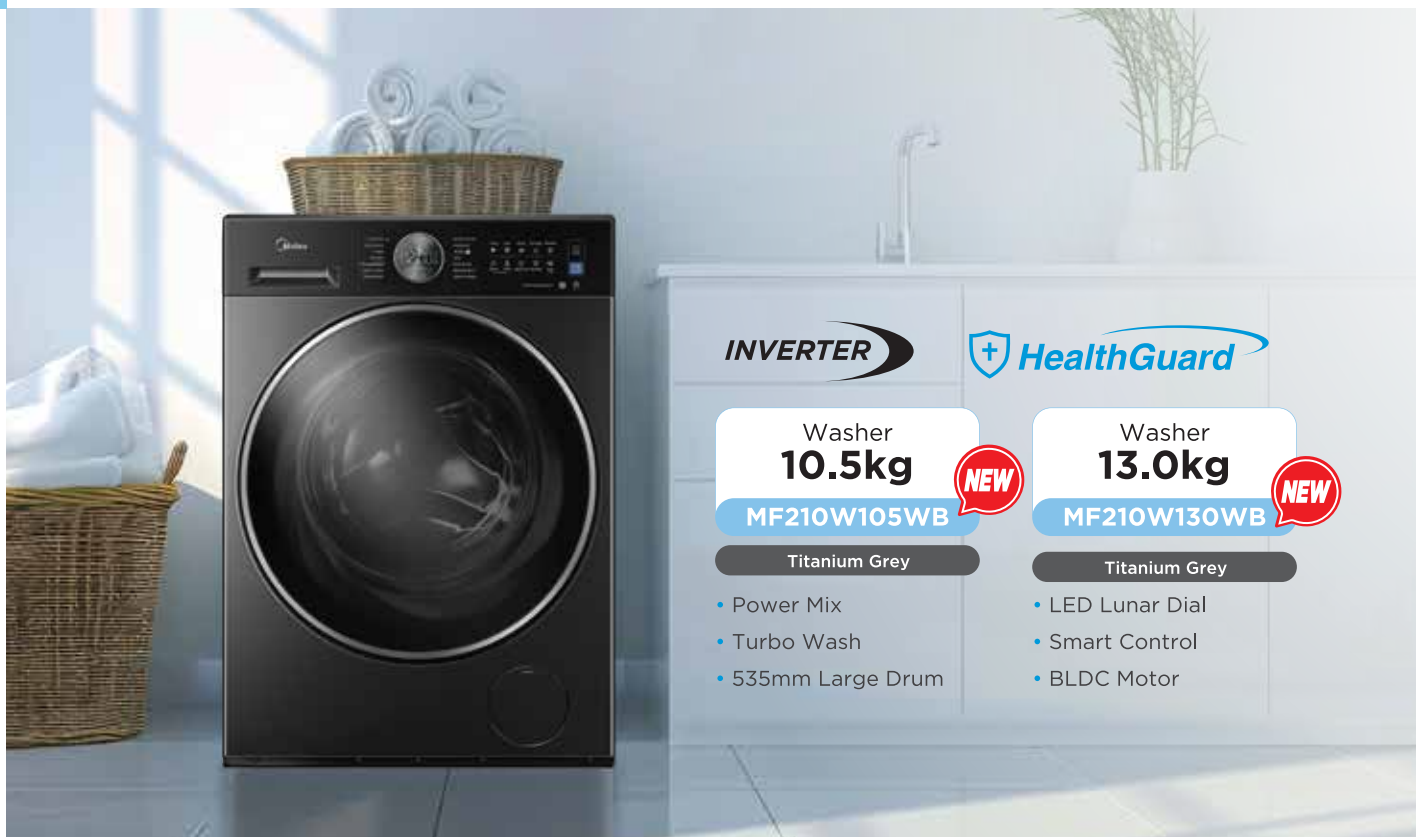

**INVERTER**

**HealthGuard**

Washer  
**10.5kg**

**NEW**

**MF210W105WB**

Titanium Grey

- Power Mix
- Turbo Wash
- 535mm Large Drum

Washer  
**13.0kg**

**NEW**

**MF210W130WB**

Titanium Grey

- LED Lunar Dial
- Smart Control
- BLDC Motor

## UNIQUE FEATURES



### TurboFoam+

Automatically adjusts detergent based on load size and weight. A small amount of water pre-mixes with the detergent to create a high-concentration foam that is evenly sprayed on clothes.



### Auto Dose

One fill for multiple washes.

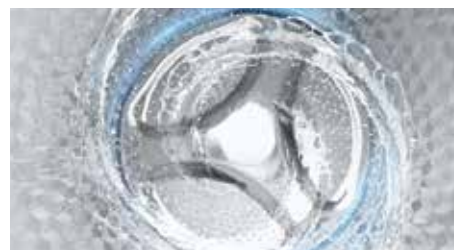

### Drum Clean

Strong 90°C hot water flows effectively clean the inner and outer drums. With MSmartHome, users will get regular reminders to run the drum clean program and keep the washing environment clean and healthy.



### HealthGuard

Hot steam penetrates deep into fabric fibers to sanitize clothes and loosen tough stains, ensuring improved hygiene and better cleaning results.



### BLDC Inverter Motor

The BLDC inverter motor minimizes energy loss and component wear, providing significant energy savings and noise reduction without impairing performance.



### Seamless Slot-in

Designed to seamlessly fit into any space, the ultra-thin body maximizes storage and ensures easy, corner-free cleaning with minimal seams.



# FRONT LOAD WASHING MACHINE



**INVERTER**

**HealthGuard**

Washer  
**8.0kg**

**MF200W80WB**

Titanium Grey

- Capacity: 8kg
- BLDC Motor

Washer  
**10.0kg**

**MF200W100WB**

Titanium Grey

- Capacity: 10kg
- BLDC Motor

Washer  
**12.0kg**

**MF200W120WB**

Titanium Grey

- Capacity: 12kg
- BLDC Motor

## UNIQUE FEATURES



### Smart Control

Connect your smart devices to SmartHome App, and easily control and enjoy the moment of free laundry whenever and wherever you are. Just unlock your favourite laundry program on your smart device and enjoy unlimited laundry possibilities.



### Lunar Dial

The knob serves as the control center which integrates the functions of knob and screen together to facilitate your operation. Just focus on the middle of the machine, and select any program and see its information at the same time.



### Enhance Your Clean And Healthy Life

HealthGuard focuses on Hygiene and Health Care. MF200 HealthGuard system points to all cycles in left line, combined with Auto Clean and Steam Care.



### Auto Clean

For every wash, high-speed water flow will clean dirt and residues on the inner and outer drums to prevent secondary pollution to the clothes.



### Steam Care

The Steam function is activated before main wash, which will generate warm steam to reach 99.99%\* sterilization and greater washing performance.

- Tested by Vkan Certification & Testing Co., Ltd.



### Turbo

Faster and Stronger washing rhythm compared to normal wash. 40% time saving to reach the same washing performance. (Only programs with "icon" added with Turbo)

(Cotton, Mix, Synthetic, Jeans, Bulky)

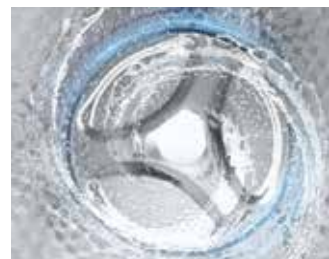

### Drum Clean

Strong 90°C hot water flows effectively clean the inner and outer drums. With MSmartHome, users will get regular reminders to run the drum clean program and keep the washing environment clean and healthy.



### Inverter Quattro

**70%** energy saving  
**10.4%** lower noise  
**10 years** durable life



# FRONT LOAD

## WASHING MACHINE



Washer  
**7.5kg**

**MF100W75**

White

- Capacity: 7.5kg
- Non-Inverter

**INVERTER**

Washer  
**8.5kg**

**MF100W85BW**

White

- Capacity: 8.5kg
- BLDC Motor

**INVERTER**

Washer  
**9.5kg**

**MF100W95BW**

White

- Capacity: 9.5kg
- BLDC Motor

## UNIQUE FEATURES

### HYGIENE 90°C

Enhanced Cleaning and Sterilization

Stubborn stains, detergent residues and harmful germs are thoroughly removed when choosing the Hygiene 90°C mode, which is beneficial for children and elders who are especially sensitive to allergens.



### AUTO CLEAN

High-speed water flow clears dirt residues off the inner and outer drum to prevent secondary pollution of the clothes.

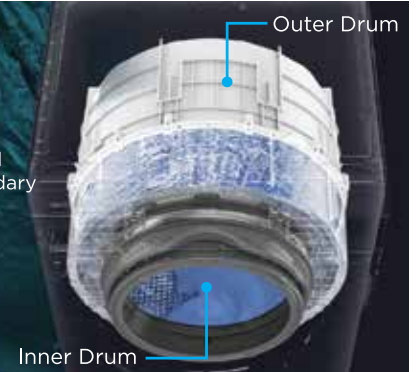

### Lunar Dial

Inspired from the splendor and purity of luna, we have Lunar Dial as the key element of Midea Laundry Series. Different from traditional knobs, Lunar Dial integrates the functions from both knob and screen display, offering you more direct laundry experience.



### Multiple Temperature

Multiple Temperature to select for gentle wash delicate clothes delicate clothes such wool, and silk.



### One-Touch Pre-Wash

Adding Pre-wash program for badly messed clothes by one step, dirty clothes will be soaked and gently washed before main cycle to achieve the best washing result.



### Inverter Quattro

**70%** energy saving  
**10.4%** lower noise  
**10 years** durable life

Extra Care for Dirty Clean



# FRONT LOAD

## WASHING MACHINE



**INVERTER**

**HealthGuard**

Washer  
**10.kg**

**NEW**

**MF110W100B**

White

- Turbo Wash
- Add Garment
- 90°C Drum Clean
- BLDC Motor

## UNIQUE FEATURES



### Turbo

Enhance the efficiency of your laundry process by utilizing the Turbo feature for quicker and more effective cleaning.



### Drum Clean

Strong 90°C hot water flows effectively clean the inner and outer drums. With MSmartHome, users will get regular reminders to run the drum clean program and keep the washing environment clean and healthy.

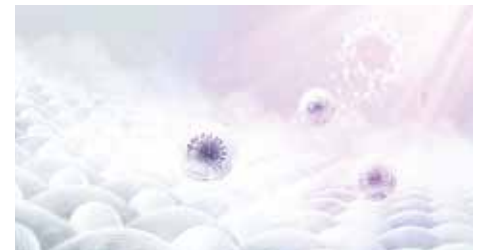

### Enhance Your Clean And Healthy Lifestyle

With HealthGuard, hot steam penetrates fabrics to loosen tough stains and eliminate bacteria, delivering a deeper clean for healthier laundry.



### Easy Control

The electroplated knob is surrounded by a stylish gray-blue arc that adds a touch of elegance. The enlarged function icons are easy to read and press, making operation more convenient.



### Multiple Washing Cycles For Diverse Fabrics



### Inverter Motor

The BLDC inverter motor eliminates energy loss and consumption of components, effectively saving energy and reducing noise without compromising performance.



# DRYER



**INVERTER**

**HealthGuard**

Dryer  
**10.0kg**

**MD210H100WB**

**NEW**

Titanium Grey

- Heat Pump Drying
- Quick Dry
- Anti Crease
- LED Lunar Dial
- Smart Control

## UNIQUE FEATURES



### Turbo

Dries your laundry faster without compromising quality. Gentle on all fabrics and perfect for the whole family.



### HealthGuard

High-temperature sanitization and UV sterilization work together to effectively eliminate bacteria and mites, keeping your clothes hygienic and safe.



### Smart Control

Connect your smart devices to SmartHome App, and easily control and enjoy the moment of free laundry whenever and wherever you are. Just unlock your favourite laundry program on your smart device and enjoy unlimited laundry possibilities.



### Seamless Slot-in

Designed to seamlessly fit into any space, the ultra-thin body maximizes storage and ensures easy, corner-free cleaning with minimal seams.



### Sensor Dry + Anti-crease

Smart sensors optimize drying to prevent heat damage, while anti-crease care reduces wrinkles for soft, fluffy clothes.



### Dual Inverter

Dual inverter conversion creates a new way of convenient, efficient, and eco-friendly drying.





**INVERTER**

**HealthGuard**

Dryer  
**10.0kg**  
**MD200H100WB**  
 Titanium Grey

- Smart Control
- Drying Cycle Auto Set
- Stack Up
- Lunar Dial
- Hygiene
- Quick Dry
- Anti Crease
- Air Fresh

## UNIQUE FEATURES



### Smart Control

Set Trapped Laundry Free Bothered about doing laundry in limited time and limited space? Try SmartHome APP. Make appointments, monitor process, get completion push...Do it remotely!



### Hygiene

Stronger Sanitization Eliminate most of the common bacteria and better protect health.



### Quick Dry

Fast Drying For Small Loads Finish drying in the time of having breakfast, taking a shower or watching just an episode.



### Lunar Dial

Information Integration Serve as the control center which integrates the functions of knob and screen to facilitate your operation.



### Anti Crease

Information Integration Drum will keep rotating after the cycle is completed to prevent wrinkles caused by piling. Less crease, more decency.



# DRYER



**INVERTER**

Dryer  
**10.0kg**  
**MD-K1088HPT**  
Titanium Grey

- Heat pump drying
- Interior lighting
- Fault check display
- Button program selection
- Transparent door
- LED display
- Electronic control
- Buzzer
- Child lock
- Reverse tumbling
- 14 Programmes and performance

## UNIQUE FEATURES

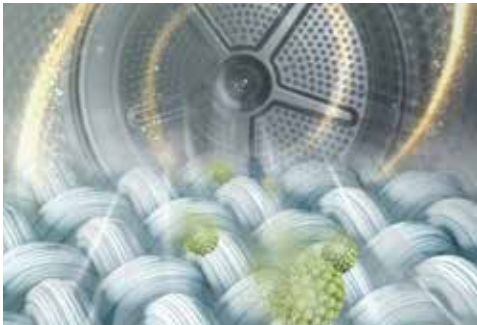

### HYGIENE

#### Dry Laundry Hygienically

After the drying cycle is completed, the inner drum will remain at the same temperature for more than 30 minutes to ensure effective sterilization.

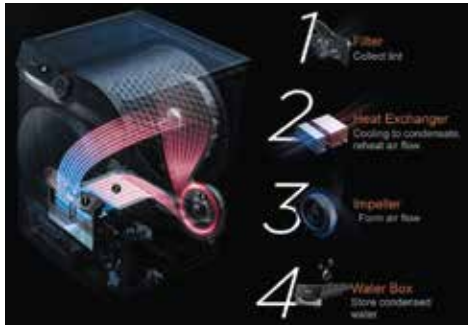

### Heat Pump Technology

- Motor drives the impeller to generate circulating air.
- The compressor works with heat exchanger to have air flow heat, and then goes into the inner drum to dry clothes.
- The air flow goes through the filter back to the heat exchanger, then cooled down to form condensate through compressor.



### Heat Pump Drying

The large capacity spreads the clothes evenly, and the strong air flow flattens wrinkles and prevents entanglement. Clothes are left soft and fluffy and can be worn immediately after drying.

### Energy and Time Saving

Heat pump system can reuse the heat generated during the drying process, thus to improve energy efficiency and reduce power consumption.



### Gentle Care

Heat pump drying controls the temperature in two directions to maintain the air temperature below 50°C and provides protection for high-grade fiber fabrics.





HealthGuard

Dryer  
**8.0kg**  
MD110H80W   
White

- Heat Pump Drying
- Quick Dry
- Anti Crease

UNIQUE FEATURES



**HYGIENE**

Stronger Sanitization Eliminate most of the common bacteria and better protect health.



**Quick Dry**

Fast Drying For Small Loads Finish drying in the time of having breakfast, taking a shower or watching just an episode.



**Anti Crease**

Drum will keep rotating after the cycle is completed to prevent wrinkles caused by piling. Less crease, more decency.



**Easy Control**

The electroplated knob is surrounded by a stylish gray-blue arc that adds a touch of elegance. The enlarged function icons are easy to read and press, making operation more convenient.



**Drum Light**

It allows you to see everything in your dryer more clearly at night, preventing missed socks or small items.



# DRYER



Dryer  
**8.0kg**

**MD200C80W**

Titanium Grey

- Smart Control
- Drying Cycle Auto Set
- Stack Up
- Lunar Dial
- Hygiene
- Quick Dry
- Anti Crease
- Air Fresh

Dryer  
**7.0kg**

**MD-100A70**

Titanium Grey

- Remaining Time Display
- Buzzer
- Safety Thermostat Heater
- E-Led Display
- Transparent Windows
- Autosensing Electronic
- 16 Programmes And Performance

Dryer  
**7.0kg**

**MD-7388**

White

- Electronic Control
- Cool-Down Phase
- Front Lint Filter
- Error Alarm
- Buzzer
- Button Program Selection
- Transparent Door
- Crease Guard Option
- Cycle Status Light



# FULLY AUTO

## WASHING MACHINE



Washer  
**11.0kg** **NEW**  
MA512W110DT  
Titanium Grey

Washer  
**13.0kg** **NEW**  
MA512W130DT  
Titanium Grey

Washer  
**15.0kg** **NEW**  
MA512W150DT  
Titanium Grey

- Rear Panel with LED Display
- Power Mix Box
- Anti-Tangling
- HealthGuard
- DD Motor

**INVERTER** **HealthGuard**

## UNIQUE FEATURES



### Transparent Detergent Box

Efficient dissolution presented visually.



### Soft Close Lid

The soft-close lid enhances safety, making the washer ideal for families with children.



### Transparent Lid

Transparent lid with larger window provides a dynamic view of washing process.



### Power Mix Box

Propelled by high-speed water flow, the rapidly spinning impeller thoroughly mixes water with washing powder, generating abundant foam, and having the washing powder fully dissolved.



### Rear Panel with LED Display

Elegantly designed rear panel with an easy-to-read LED display for effortless operation.



### Anti-Tangling

Three powerful waterflows effectively remove all stains, ensuring efficient and thorough cleaning, and less tangling.



# FULLY AUTO

WASHING MACHINE



Washer  
**7.5kg**  
MA200W75  
Grey

Washer  
**8.5kg**  
MA200W85G  
Grey

Washer  
**9.5kg**  
MA200W95  
Grey

Washer  
**10.5kg**  
MA200W105  
Grey

Washer  
**12.5kg**  
MA200W125  
Grey

- Auto Clean
- Hygiene
- One Touch Wash
- Lunar Dial
- Detergent Box



Washer  
**11.0kg**  
MA200W110DT  
Titanium Grey

Washer  
**13.0kg**  
MA200W130DT  
Titanium Grey

Washer  
**15.0kg**  
MA200W150D  
Titanium Grey

- Auto Clean
- Hygiene
- One Touch Wash
- Lunar Dial
- Independent Design for Softener
- DD Motor

## INVERTER QUATTRO

Energy Saving and Silent Operating



**STABLE**  
The motor directly drives the inner drum, providing stronger power and keeping stable operating.



**EFFICIENCY**  
Precisely control the washing rhythm to improve washing efficiency and effect.



**QUIET**  
Prolonged service life and significant lower noises.



**SAVING**  
Space saving compared with other washers of the same capacity.

## UNIQUE FEATURES

### AUTOCLEAN

#### From Inner to Outer Drum

##### Avoid secondary pollution

The water flushes between the inner and outer drums throughout the whole self-cleaning process, removing dirt and residues away to maintain a healthy washing environment.



Powerful water flow flushes between the inner and outer drums, removing dirt and residues away.



Auto Clean cycle is automatically activated during drain process, ensuring a clean and safe washing condition.



**Soft Close**  
Matte Glass Lid

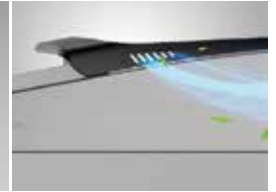

**Airfresh**  
All-around Fresh Care



**3+1 CHANNELS**

### DEEP CLEAN

#### 3D Cyclone Cleaning System

The water cube impeller and drum form cyclone water flows to deeply clean the mixed clothes of different types and prevent them from twining at the same time.

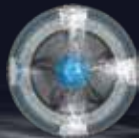

#### PULSATOR

The lifting flow generated by the impeller in the pulsator cleans the laundry more deeply.

#### WATER CUBE TUB

The water cube tub is designed to imitate hand washing which provides gentle care for clothes.

#### 3+1 CHANNELS

The 3+1 powerful water flows can effectively prevent tangles from generating.

### Lunar Dial

#### Working Status at a Glance

Inspired from Midea logo, integrated with program display and process tracking, Lunar Dial is regarded as Midea Laundry's key visual element.



### Independent Design For Softener

#### Smooth Laundry Better

\*exclude MA200W75 & MA200W85G

## Hygiene

#### Advanced Cleaning and Sanitization

For children and seniors who are more sensitive to bacterium and germs, Hygiene provides special care to protect their health.

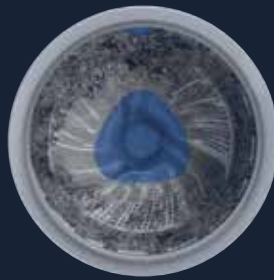

Based on original programs, Hygiene provides:



Prolonged washing time



Enhanced tempo and water flow



3 times rinsing (Once more)

### 15' Quick Wash

A Cycle for small loads of laundry will be finished within 15 minutes. Never in a hurry, and always be at your best.



### Water Cub Tub

Imitate hand washing to provide gentle care for clothes.

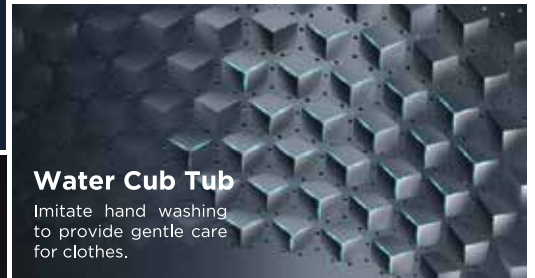

### ONE TOUCH WASH

#### Fuzzy Logic Technology

Just power on and press Start.

The Fuzzy Logic is activated to weigh the laundry and automatically select the proper program accordingly. Water level and time is set, offering you a worryless laundry experience.



1 Power on



2 Start

to activate Intelligent Washing.

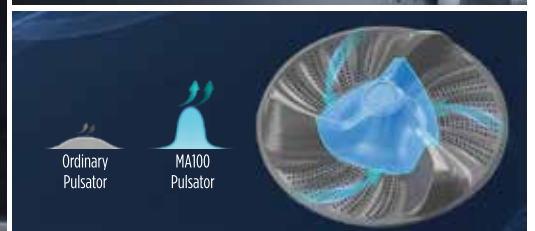

Ordinary Pulsator

MA100 Pulsator

#### Pulsator

Lifting flow propelled by the impeller prevents tangle and knot.

# FULLY AUTO

WASHING MACHINE

Nautilus SERIES



**INVERTER**

Washer  
**17.0kg**

**MAN01W170D**

Titanium Grey

- Higher Back Control Panel
- Transparent Lid
- Fuzzy Logic
- Four In One Detergent Box
- Water Cube Drum
- Water Magic Flow
- Strong Wash
- One Touch

## UNIQUE FEATURES



### Higher Back Control Panel

Most comfortable viewing angle for better user experience.



### Transparent Lid

Transparent lid with larger window provides a dynamic view of washing process.



### Fuzzy Logic

Fuzzy logic optimizes water intake and washing cycles length by weighing the laundry load.



### Fuzzy

- Automatic Load Weighing
- Cycle length adjustor
- Water Inflow Evaluator
- Economical Wash

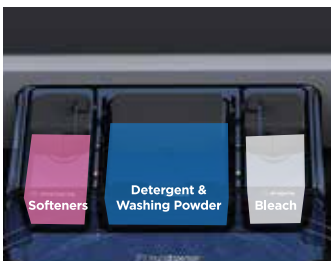

### Four In One Detergent Box

Add detergent/washing powder, softener and bleach at one time, and leave it to the washer to dispense in turns.

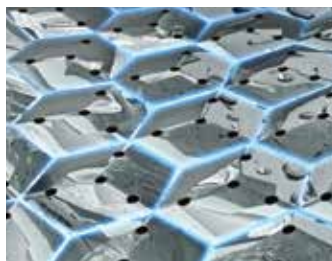

### Water Cube Drum

Creative "Water Cube" drum effectively helps "massage" clothes, soak fabrics, completely solve stain problems and clean fabric corners. No more worries about stubborn stains, enjoy your laundry days.



### Water Cube Drum

Tough on stains, gentle on fabrics. Smaller holes prevent fabrics from being damaged. Numberless water jets squirt out of the narrow holes to wash your clothes in the most effective way.



### Water Magic Flow

Quickly and completely dissolve stains and get less wear & tear on the clothes.



# FULLY AUTO WASHING MACHINE



Washer  
**7.5kg**  
MA102W75  
Grey

Washer  
**8.5kg**  
MA102W85  
Grey

- Auto Clean
- Hygiene
- One-Touch Smart Wash
- Easy-to-clean Metal Lint Filter



## UNIQUE FEATURES

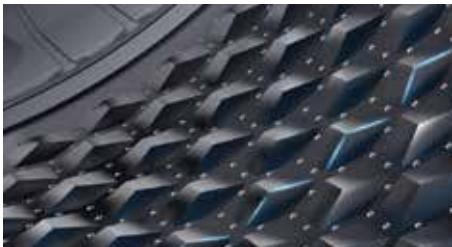

### Water Cub Tub

Imitate hand washing to provide gentle care for clothes.

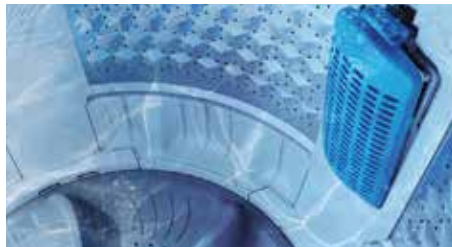

### Easy-to-clean

Cleaning the filter regularly ensures a better washing result.

Metal Lint Filter

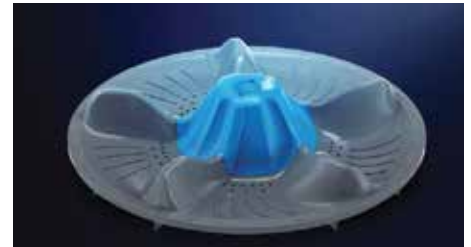

### Pulsator

Lifting flow propelled by the impeller prevents tangle and knot.

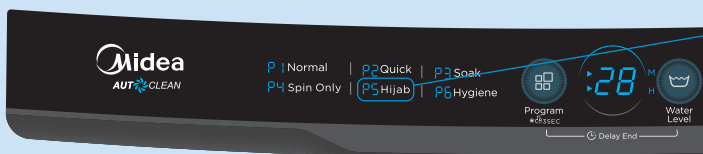

### P5 Hijab

This program helps maintain the fabric's quality and keep it in good condition for longer, ensuring gentle and effective care for your hijabs.



# FULLY AUTO

WASHING MACHINE



Washer  
**9.5kg**  
MA102W95  
Titanium Grey

Washer  
**10.5kg**  
MA102W105  
Titanium Grey

- Auto Clean
- Hygiene
- One-Touch Smart Wash
- Tempered Glass Lid Cover
- Soft Close Lid
- Easy-to-clean Metal Lint Filter



## UNIQUE FEATURES

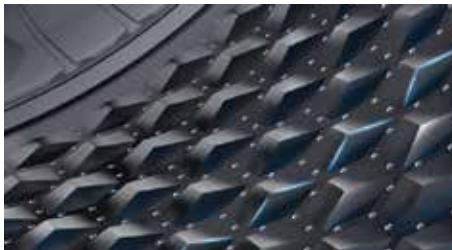

### Water Cub Tub

Imitate hand washing to provide gentle care for clothes.



### Easy-to-clean

Cleaning the filter regularly ensures a better washing result.

Metal Lint Filter

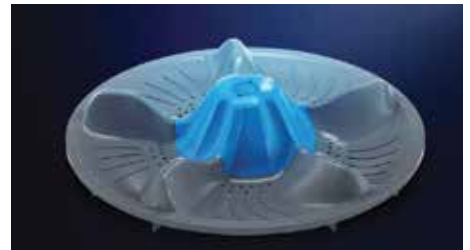

### Pulsator

Lifting flow propelled by the impeller prevents tangle and knot.

## Easy-to-clean Metal Lint Filter



**1.** Lint, hair, tissues and residues are effectively collected.



**2.** Flush water through to clean up the filter.



**3.** Click. All set.



# SEMI AUTO WASHING MACHINE



## UNIQUE FEATURES



### Durable Body

The body design is mainly made of anti-rust material, which is hardly rusted and more flexible than steel. Even in tough circumstances, it's more durable and hard to be dented.



### Higher Back Control Panel

Best viewing angle for better user experience.



### Large Knob Design

Easy to operate and recognize functions displayed.



### Humanized Hook Design

The washing tank cover is removable. And the hook is designed as kit for hanging the cover to free your hands.



### Dual Force Pulsator

The independent big and small pulsators will generate different water flows in multiple directions and levels to stimulate hand-washing performance.



### Airfresh

Thanks to the unique AirFresh design, the water can be effectively taken away from clothes by the inner and outer air circulation.



### Easy-to-clean Metal Lint Filter

The removable filter is made of Metal material which ensure **HYGIENE** condition during the washing process, it can also be easily taken out, so that leading it to be simple to clean up the lint, fluff and particles. It only takes a small effort to keep your machine working its best.



### Water Inlet Selection

The switch can control water inlet direction, switch to left to let water flow in wash drum and right to let water flow in spin drum which can enhance rinsing effect.

Hence there's no need to move water inlet pipe anymore.



# SEMI AUTO

WASHING MACHINE



Washer  
**6.0kg**  
MSW-6008P



Washer  
**7.0kg**  
MSW-7118P



Washer  
**8.0kg**  
MSW-8008P

Washer  
**9.0kg**  
MSW-9008P

Washer  
**11.0kg**  
MSW-1108P



# SPECIFICATION



## Washer & Dryer Combo

Model	MF310D105WB	MF210D150WB	MF210D105WB	MF200D85B
Capacity	Wash 10.5kg Dry 7.0kg	Wash 15.0kg Dry 9.0kg	Wash 10.5kg Dry 7.0kg	Wash 8.5kg Dry 6.0kg
Gross Weight (kg)	72	79	72	68
Net Weight (kg)	66	85	66	65
Carton Dimension (WxDxH) mm	700x705x985	715x795x890	700x705x985	650x555x885
Net Dimension (WxDxH) mm	595x580x850	595x685x850	595x580x850	595x475x850



## Washer & Dryer Combo

## Laundry Suite

Model	MF200D85WBT	MF200D100WB	MF200D120WB	ML19F100D80WT-W	ML19F100D80WT-D
Capacity	Wash 8.5kg Dry 6.0kg	Wash 10.0kg Dry 7.0kg	Wash 12.0kg Dry 8.0kg	Wash 10.0kg	Dry 8.0kg
Gross Weight (kg)	68	69	78	70	51
Net Weight (kg)	65	65	73	65	45
Carton Dimension (WxDxH) mm	655x560x885	680x660x875	680x725x875	700x665x985	700x705x985
Net Dimension (WxDxH) mm	595x475x850	595x535x850	595x595x850	595x559x850	595x559x830



## Front Load

Model	MF210W105WB	MF210W130WB	MF200W80WB	MF200W100WB	MF200W120WB
Capacity	Wash 10.5kg	Wash 13.0kg	Wash 8.0kg	Wash 10.0kg	Wash 12.0kg
Gross Weight (kg)	73kg	76kg	66	69	77
Net Weight (kg)	68kg	72kg	63	65	72
Carton Dimension (WxDxH) mm	680x665x885	680x725x885	655x560x885	660x680x875	725x680x875
Net Dimension (WxDxH) mm	595x580x850	595x620x850	595x475x850	595x535x850	595x595x850



# SPECIFICATION



## Front Load

Model	MF100W75	MF100W85BW	MF100W95BW	MF110W100B
Capacity	Wash 7.5kg	Wash 8.5kg	Wash 9.5kg	Wash 10.0kg
Gross Weight (kg)	58	63	65	61
Net Weight (kg)	55	60	61	66
Carton Dimension (WxDxH) mm	655x500x885	655x560x885	655x580x885	680x660x885
Net Dimension (WxDxH) mm	595x400x850	595x475x850	595x495x850	595x535x850



## Dryer

Model	MD210H100WB	MD200H100WB	MD-K1088HPT	MD110H80W
Capacity	10.0kg	10.0kg	10.0kg	8.0kg
Gross Weight (kg)	53	52	58	42
Net Weight (kg)	58	48	53	46
Carton Dimension (WxDxH) mm	712x760x895	679x709x885	685x695x885	710x660x890
Net Dimension (WxDxH) mm	595x685x850	595x675x845	595x640x845	600x595x850



## Dryer

Model	MD200C80W	MD-100A70	MD-7388
Capacity	8.0kg	7.0kg	7.0kg
Gross Weight (kg)	43	34	37
Net Weight (kg)	40	30	31.5
Carton Dimension (WxDxH) mm	680x660x880	670x580x890	670x580x890
Net Dimension (WxDxH) mm	595x615x845	595x555x840	595x555x840

# SPECIFICATION



## Fully Auto

Model	MA512W110DT	MA512W130DT	MA512W150DT
Capacity	11.0kg	13.0kg	15.0kg
Gross Weight (kg)	46	46	51
Net Weight (kg)	41	41	44
Carton Dimension (WxDxH) mm	627x636x1070	627x636x1070	660x685x1140
Net Dimension (WxDxH) mm	580x596x1015	580x596x1015	601x615x1050



## Fully Auto

Model	MA200W75	MA200W85G	MA200W95	MA200W105	MA200W125
Capacity	7.5kg	8.5kg	9.5kg	10.5kg	12.5kg
Gross Weight (kg)	35	35	40	45	46
Net Weight (kg)	31	31	36	41	42
Carton Dimension (WxDxH) mm	575x585x970	580x590x1005	618x628x995	616x630x1025	621x630x1025
Net Dimension (WxDxH) mm	515x525x915	515x525x936	550x565x915	580x596x965	580x596x962



# SPECIFICATION



## Fully Auto

Model	MA200W110DT	MA200W130DT	MA200W150D	MAN01W170D
Capacity	11.0kg	13.0kg	15.0kg	17.0kg
Gross Weight (kg)	40	47	50	58
Net Weight (kg)	35	42	46	53
Carton Dimension (WxDxH) mm	626x635x1030	660x685x1065	660x685x1065	707x737x1170
Net Dimension (WxDxH) mm	550x565x950	601x630x1000	601x630x1000	640x684x1085



## Fully Auto

Model	MA102W75	MA102W85	MA102W95	MA102W105
Capacity	7.5kg	8.5kg	9.5kg	10.5kg
Gross Weight (kg)	33	33	41	41
Net Weight (kg)	29	29	35.5	35.5
Carton Dimension (WxDxH) mm	580x590x980	580x590x980	652x652x1060	652x652x1060
Net Dimension (WxDxH) mm	515x530x900	515x530x900	550x565x930	550x565x930



# SPECIFICATION



## Semi Auto

Model	MSW-6008P	MSW-7118P	MSW-8008P	MSW-9008P	MSW-1108P
Capacity	6.0kg	7.0kg	8.0kg	9.0kg	11.0kg
Gross Weight (kg)	21	21	23	25	26
Net Weight (kg)	18	18	19	21	23
Carton Dimension (WxDxH) mm	760x453x885	760x453x885	778x475x918	840x505x900	886x546x992
Net Dimension (WxDxH) mm	735x430x845	735x430x845	761x448x885	827x485x865	870x512x957



## Semi Auto

Model	MT100W70	MT100W80	MT100W90	MT100W100
Capacity	7.0kg	8.0kg	9.0kg	10.0kg
Gross Weight (kg)	21	23	26	28
Net Weight (kg)	18.5	20	22	23
Carton Dimension (WxDxH) mm	760x453x885	778x475x920	870x520x950	970x520x1020
Net Dimension (WxDxH) mm	735x430x855	761x448x885	827x485x895	827x485x975



## Semi Auto

Model	MT100W110	MT100W120	MT100W130	MT100W140	MT100W150
Capacity	11.0kg	12.0kg	13.0kg	14.0kg	15.0kg
Gross Weight (kg)	27	31	35	36	44
Net Weight (kg)	23	26	30.5	30.5	37.5
Carton Dimension (WxDxH) mm	886x546x1000	886x546x1055	950x580x1045	950x580x1090	1020x580x1185
Net Dimension (WxDxH) mm	870x512x950	870x512x1020	902x537x998	902x537x1050	995x555x1105