



WASHING MACHINE

Front Loading



USER MANUAL

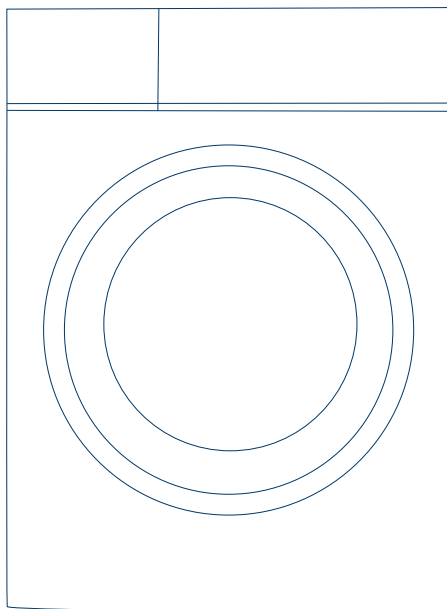

Read This Manual

Use all instructions and explanations of the installation before use. Follow the instructions carefully. Keep the operation instructions handy for later use. If the application is sold or passed on then ensure that the new owner always receives those operation instructions.

**MODEL:
MF100W75**

CONTENTS

Safety Instructions

- Safety Instructions 2

Installation

- Product Description 8
- Installation 9

Operations

- Quick Start 12
- Before Each Washing 13
- Detergent Dispenser 14
- Control Panel 15
- Option..... 16
- Other Functions 17
- Programmes..... 19
- Washing Programmes Table 20

Maintenances

- Cleaning And Care 21
- Trouble Shooting 24
- Technical Specifications 25

SAFETY INSTRUCTIONS

■ Safety Instructions

- This appliance is not intended for use by persons(includingchildren) with reduced physical,sensory or mental capabilities or lack of experience and knowledge unless they have been given supervision or instruction concerning use of the appliance by a person responsible for their safety.
- Children should be supervised to ensure that they do not play with the appliance.
- If the supply cord is damaged, it must be replaced by the manufacturer, its service agent or similarly qualified persons in order to avoid a hazard.
- The new hose-sets supplied with the appliance are to be used and that old hose-sets should not be reused.
- The openings must not be obstructed by a carpet.
- This appliance is intended to be used in household and similar applications such as:
 - staff kitchen areas in shops, offices and other working environments;
 - farm houses;
 - by clients in hotels, motels and other residential type environments;
 - bed and breakfast type environments;
 - areas for communal use in blocks of flats or in launderettes.

SAFETY INSTRUCTIONS

■ Safety Instructions

For your safety, the information in this manual must be followed to minimize the risk of fire or explosion, electric shock, or to prevent property damage, personal injury or loss of life.

Explanation of the symbols:

Warning!

This combination of symbol and signal word indicates a potentially dangerous situation which may result in death or serious injuries unless it's avoided.

Caution!

This combination of symbol and signal word indicates a potentially dangerous situation which may result in slight or minor injuries or damage to property and the environment.

Note!

This combination of symbol and signal word indicates a potentially dangerous situation which may result in slight or minor injuries.

Warning!

The electric shock!

SAFETY INSTRUCTIONS

- Before any maintenance the device, unplug the appliance from the mains.
- Always unplug the machine and turn off the water supply after use. The max. inlet water pressure, in pascals. The min. inlet water pressure, in pascals.
- To ensure your safety, power plug must be inserted into an earthed three-pole socket. Check carefully and make sure that your socket is properly and reliably earthed.
- Make sure that the water and electrical devices must be connected by a qualified technician in accordance with the manufacturer's instructions and local safety regulations.
- Plug must be accessible after installation.
- Pull out its plug and cut off water supply after the operation.
- Take care that power voltage and frequency shall be identical to those of washing machine.
- Glass door may be very hot during the operation. Keep kids and pets far away from the machine during the operation very wet rooms as well as in the rooms with explosive or caustic gas.
- Remove all packages and transport bolts before using the appliance. Otherwise, serious damage may result.
- The washing machine with single inlet valve only can be connected to the cold water supply. The product with double inlet valves should be correctly connected to the hot water and cold water supply.

SAFETY INSTRUCTIONS

- Do not use any socket with rated current less than that of appliance. Never pull out power plug with wet hand.

Risk to children!

- Children of less than 3 years should be supervised to ensure that they do not play with appliance.
- Animals and children may climb into the machine. Check the machine before every operation.
- Kids should be supervised that they do not play with the appliance.

Risk of explosion!

- Do not wash or dry articles that have been cleaned in, washed in, soaked in, or dabbed with combustible or explosive substances(such as wax, oil, paint, gasoline, degreasers, dry-cleaning solvents, kerosene, etc.) This may result in fire or explosion.
- Before hand thoroughly rinse items of washing by hand.

⚠ Caution!

Installing the product!

- This washing machine is for indoor use only.

SAFETY INSTRUCTIONS

- It isn't intended to be built-in using.
- Washing machine shall not be installed in bath room or very wet rooms as well as in the rooms with explosive or caustic gases.
- Remove all packages and transport bolts before using the appliance. Otherwise, serious damage may result.
- The washing machine with single inlet valve only can be connected to the cold water supply. The product with double inlet valves should be correctly connected to the hot water and cold water supply.
- Plug must be accessible after installation.

Risk of damaging appliance!

- Your product is only for home use and is only designed for the textiles suitable for machine washing.
- Do not climb up and sit on top cover of the machine.
- Do not lean against machine door.
- Cautions during Handling Machine:
 - 1.Transport bolts shall be reinstalled to the machine by a specialized person.
 - 2.The accumulated water shall be drained out of the machine.
 - 3.Handle the machine carefully. Never hold each protruded part on the machine while lifting. Machine door can not be used as the handle during the conveyance.
 - 4.This appliance is heavy. Transport with care.
 - 5.A precaution indicates that the hands shall not be inserted into running water-extracting tub.

SAFETY INSTRUCTIONS

6.A precaution indicates that the appliance shall not be installed at a humid place.

- Please do not close the door with excessive forces. If it is found difficult to close the door, please check if the clothes are put in or distributed well.
- It is forbidden to wash carpets.

Operating the appliance!

- Before washing the clothes at first time, the product shall be operated in one round of the whole procedures without the clothes inside.
- Flammable and explosive or toxic solvents are forbidden. Gasoline and alcohol etc. Shall not be used as detergents. Please only select the detergents suitable for machine washing, especially for drum.
- Make sure that all pockets are emptied. Sharp and rigid items such as coin, brooch, nail, screw or stone etc. may cause serious damages to this machine.
- Please check whether the water inside the drum has been drained before opening its door. Please do not open the door if there is any water visible.
- Be careful of burning when the product drains hot washing water.
- Never refill the water by hand during washing.
- After the program is completed, Please wait for two minutes to open the door.

INSTALLATION

■ Product Description

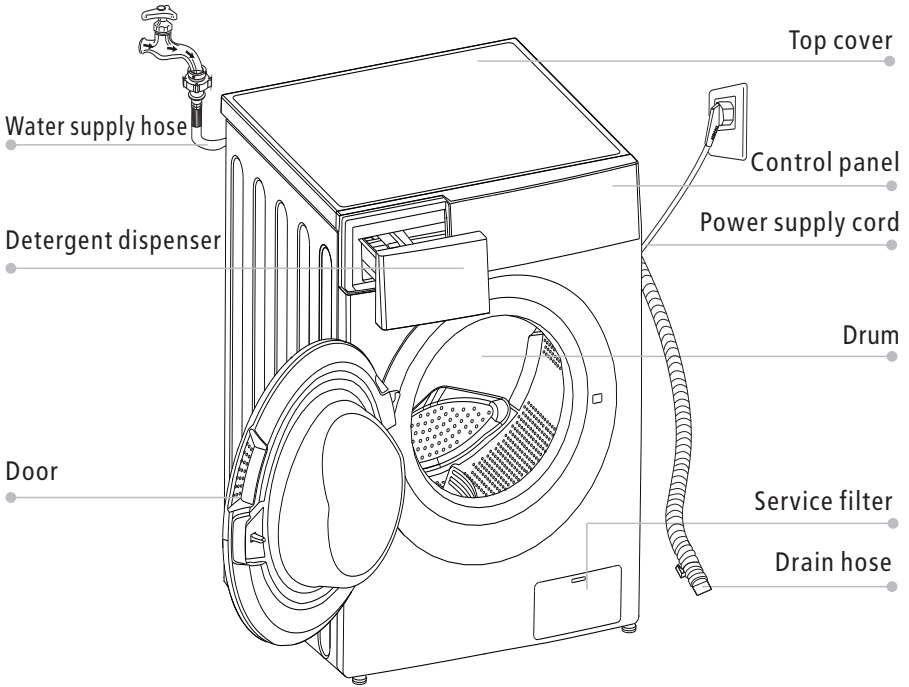

Note!

- The product line chart is for reference only, please refer to real product as standard.

Accessories

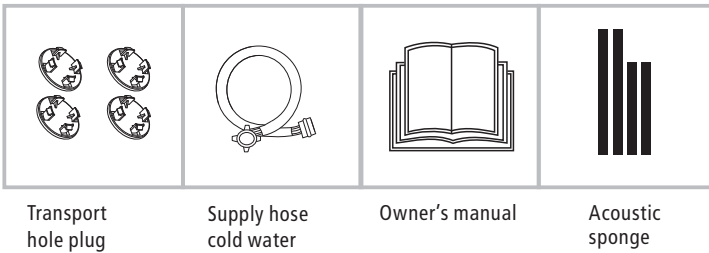

INSTALLATION

■ Installation

Installation area

⚠ Warning!

- Stability is important to prevent the product from wandering!
- Make sure that the product should not stand on the power cord.

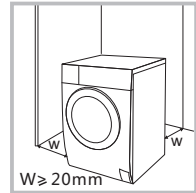

Before installing the machine, the location characterized as follows shall be selected:

1. Rigid, dry, and level surface
2. Avoid direct sunlight
3. Sufficient ventilation
4. Room temperature is above 0°C
5. Keep far away from the heat resources such as coal or gas.

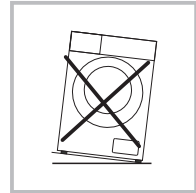

Unpacking the washing machine

⚠ Warning!

- Packaging material (e.g. Films, Styrofoam) can be dangerous for children.
- There is a risk of suffocation ! Keep all packaging well away from children.

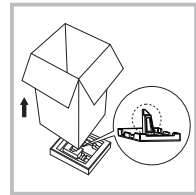

1. Remove the cardboard box and styrofoam packing.
2. Lift the washing machine and remove the base packing. Make sure the small triangle foam is removed with the bottom one together. If not, lay the unit down with side surface, then remove the small foam from the unit bottom manually.
3. Remove the tape securing the power supply cord and drain hose.
4. Remove the inlet hose from the drum.

Remove transport bolts

⚠ Warning!

- You must remove the transport bolts from the backside before using the product.
- You'll need the transport bolts again if you move the product, so make sure you keep them in a safe place.

Please take the following steps to remove the bolts:

1. Loosen 4 bolts with spanner and then remove them.
2. Stop the holes with transport hole plugs.
3. Keep the transport bolts properly for future use.

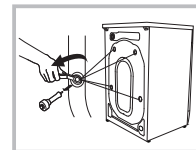

INSTALLATION

Levelling the washing machine

⚠ Warning!

- The lock nuts on all four feet must be screwed tightly against the housing.

1. Check if the legs are closely attached to the cabinet. If not, please turn them to their original positions tighten the nuts.
2. Loosen the lock nut turn the feet until it closely contacts with the floor.
3. Adjust the legs and lock them with a spanner, make sure the machine is steady.

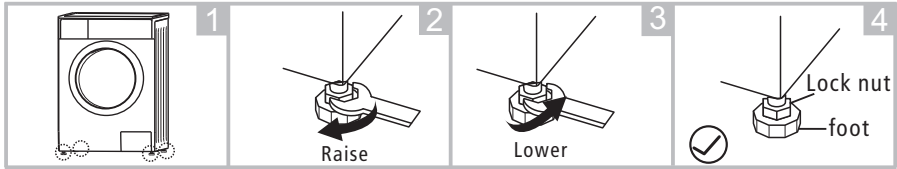

Connect Water Supply Hose

⚠ Warning!

- To prevent leakage or water damage, follow the instructions in this chapter!
- Do not kink, crush, modify or sever water inlet hose.
- For the model equips hot valve, connect it to hot water tap with hot water supply hose. Energy consumption will decrease automatically for some program.

Connect the inlet pipe as indicated, There are two ways to connect the inlet pipe.

1. Connection between screw tap and inlet hose.

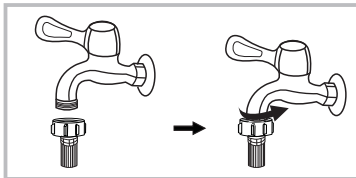

Tap with threads and inlet hose

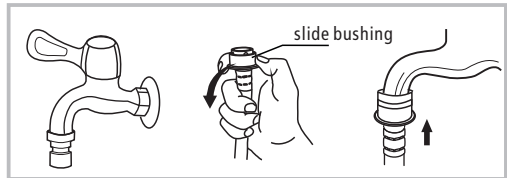

Special tap for washing machine

Connect the other end of inlet pipe to the inlet valve at the backside of product and fasten the pipe tightly clockwise.

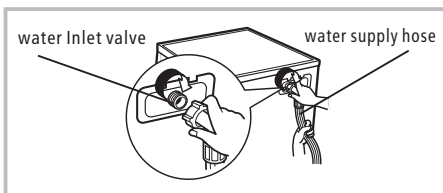

INSTALLATION

Drain Hose

⚠ Warning!

- Do not kink or protract the drain hose.
- Position drain hose properly ,otherwise damage might result of water leakage.

There are two ways to place the end of drain hose:

1.Put it into the water trough.

2.Connect it to the branch drain pipe of the trough.

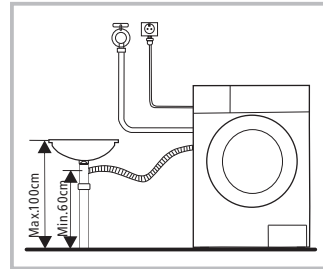
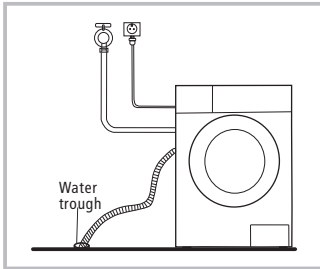

Acoustic Sponge

📌 Note!

- Please make sure to assemble the acoustic sponges, which can effectively reduce the noise caused by the machine while working, in order to provide you with a more peaceful and quiet living environment.

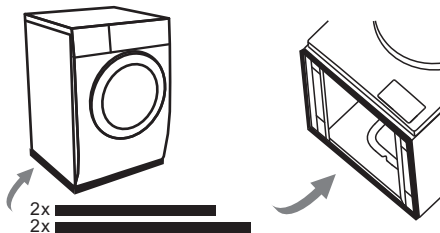

1. Get the machine laid on the floor, using some soft material like foam or clothes between the machine and floor for a protection;
2. Stick the 2x longer sponges to the longer bottom edges of machine, and the 2x shorter sponges to the shorter bottom edges.

OPERATIONS

■ Quick Start

⚠ Caution!

- Before washing, please make sure it's installed properly.
- Before washing at first time, the washing machine shall be operated in one round of the whole procedures without clothes in as follows.

1. Before Washing

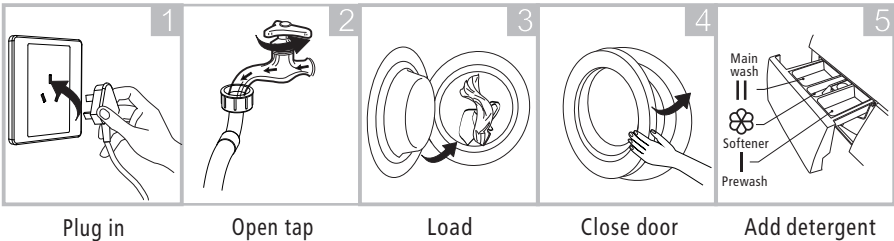

📌 Note!

- Detergent only need to be added in "case I " after selecting pre-washing for machines with this function.

2. Washing

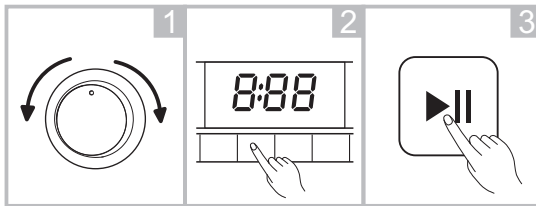

📌 Note!

- 1.If default is selected, step 3 can be skipped.
- 2.The function button line chart is for reference only, please refer to real product as standard.

3. After Washing

Buzzer beep or "End" on display.

OPERATIONS

■ Before Each Washing

- The working condition of the washer should be (0-40)°C. If used under 0°C, the inlet valve and draining system may be damaged. If the machine is placed under condition of 0°C or less, then it should be transferred to normal ambient temperature to ensure the water supply hose and drain hose are not frozen before use.
- Please check the labels and the explanation of using detergent before wash. Use non-foaming or less-foaming detergent suitable for machine washing properly.

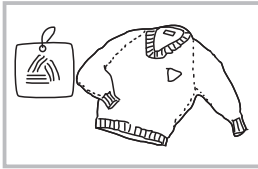

Check the label

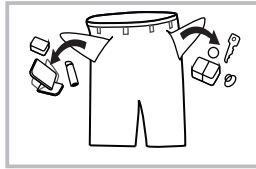

Take out the items out of the pockets

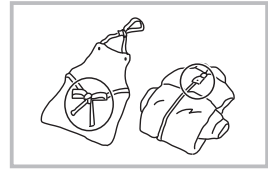

Knot the long strips, zip or button

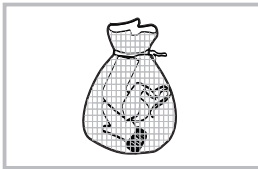

Put small clothes into the pillow slip

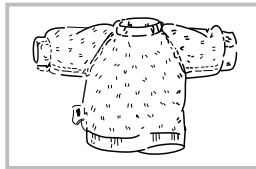

Turn easy-pilling and long-pile fabric inside out

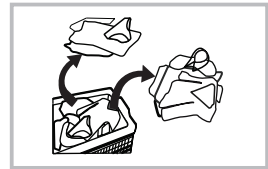

Separate clothes with different textures

⚠ Warning!

- When washing a single clothes, it may easily cause great eccentricity and give alarm due to great unbalance. Therefore it is suggested to add one or two more clothes to be washed together so that draining can be done smoothly.
- Don't washing the clothes touching with kerosene, gasoline, alcohol and other flammable materials.

OPERATIONS

■ Detergent Dispenser

- I Pre wash detergent
- II Main wash detergent
- ☼ Softener

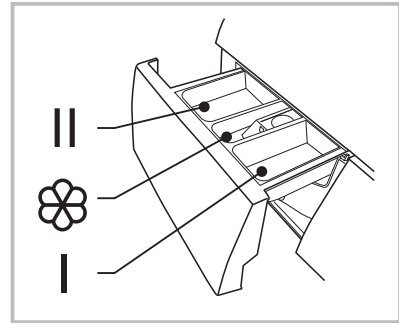

Pull out the dispenser

⚠ Caution!

- Detergent only need to be added in "case I " after selecting pre-washing for product with this function.

Programme	I	II	☼	Programme	I	II	☼
Cotton Cold	○	●	○	Spin only			
Cotton 20°C	○	●	○	Hygiene 90°C	○	●	○
Cotton 40°C	○	●	○	Mix 60°C	○	●	○
Cotton 60°C	○	●	○	Mix 40°C	○	●	○
Jeans	○	●	○	Mix 20°C	○	●	○
Delicate		●	○	Rapid 45'	○	●	○
ECO 40-60		●	○	Quick 15'		●	○
Rinse & Spin			○				

- Means must
- Means optional

📌 Note!

- As for the agglomerated or ropy detergent or additive, before they are poured into the detergent box, it is suggested to use some water for dilution to prevent the inlet of detergent box from being blocked and overflowing while filling water.
- Please choose suitable type of detergent for the various washing temperature to get the best washing performance with less water and energy consumption.

OPERATIONS

■ Control Panel

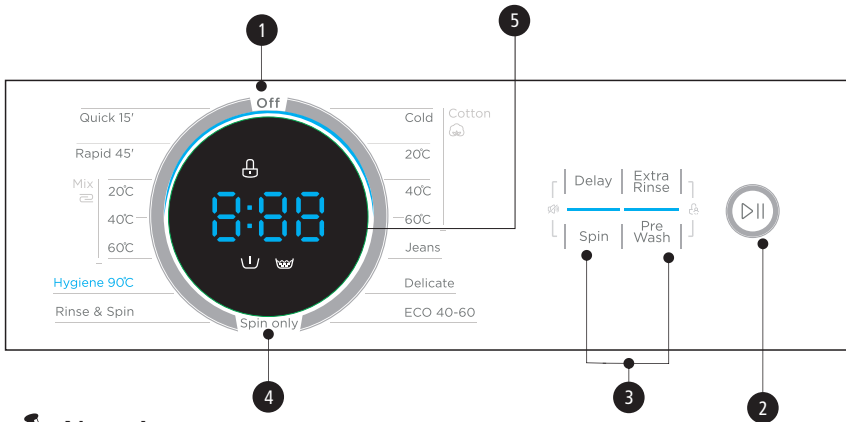

Note!

- The chart is for reference only, Please refer to real product as standard.

1 Off

Product is switched Power.

2 Start/Pause

Press the button to start or pause the washing cycle.

3 Option

This allows you to select an additional function and will light when selected.

4 Programmes

Available according to the laundry type.

5 Display

The display shows the settings, estimated time remaining, options, and status messages for your washer. The display will remain on through the cycle.

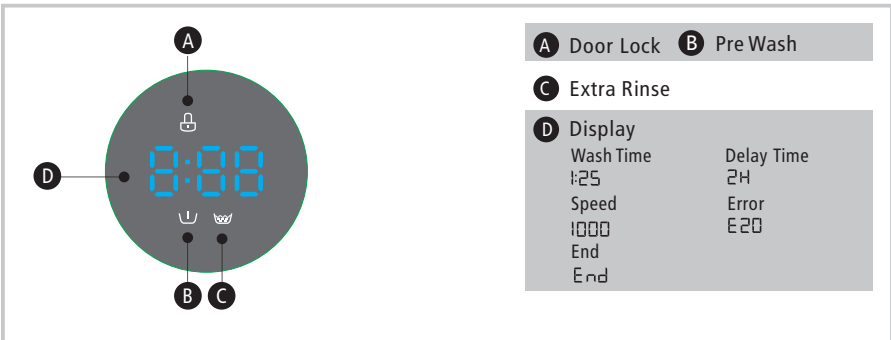

OPERATIONS

■ Option



Pre Wash

The Prewash function can get an extra wash before main wash, it is suitable for washing the dust rises to surface of the clothes; You need to put detergent into the Case (I) when select it.



Extra Rinse

The laundry will undergo extra rinse once after you select it.



Delay

Set the Delay function:

1. Select a programme
2. Press the Delay button to choose the time (the delaying time is 0-24 H.)
3. Press [Start/Pause] to commence the delay operation



Choose the Programme

Setting time

Start

Cancel the Delay function:

Press the [Delay] button until the display be 0H. It should be pressed before starting the programme. If the programme already started, should select [Off] to reset the programme.

⚠ Caution!

- If there is any break in the power supply while the machine is operating, a special memory stores the selected programme and when the power is restarted, press the [Start/Pause] button the program will continue.

Programme	Option			Programme	Option		
	Delay	Pre Wash	Extra Rinse		Delay	Pre Wash	Extra Rinse
Cotton Cold	<input type="radio"/>	<input type="radio"/>	<input type="radio"/>	Spin only	<input type="radio"/>		
Cotton 20°C	<input type="radio"/>	<input type="radio"/>	<input type="radio"/>	Hygiene 90°C	<input type="radio"/>	<input type="radio"/>	<input type="radio"/>
Cotton 40°C	<input type="radio"/>	<input type="radio"/>	<input type="radio"/>	Mix 60°C	<input type="radio"/>	<input type="radio"/>	<input type="radio"/>
Cotton 60°C	<input type="radio"/>	<input type="radio"/>	<input type="radio"/>	Mix 40°C	<input type="radio"/>	<input type="radio"/>	<input type="radio"/>
Jeans	<input type="radio"/>	<input type="radio"/>	<input type="radio"/>	Mix 20°C	<input type="radio"/>	<input type="radio"/>	<input type="radio"/>
Delicate	<input type="radio"/>		<input type="radio"/>	Rapid 45'	<input type="radio"/>	<input type="radio"/>	<input type="radio"/>
ECO 40-60	<input type="radio"/>			Quick 15'	<input type="radio"/>		
Rinse & Spin	<input type="radio"/>		<input type="radio"/>				

Means optional

OPERATIONS

Other functions



Child Lock
To avoid mis operation by children.



Start

Press [Extra Rinse] and [Pre Wash]
3 sec. till buzzer beep.

⚠ Caution!

- Press the two button 3sec. also to be released the function.
- The "Child Lock" will lock all buttons except [Off].
- Cut off the power supply , the kid's protection is to be released.
- The child lock will remain effective when the power is resumed for some models.



Spin
Press the button to change the spin speed.
1000: 0-400-600-800-1000 1200: 400-600-800-1000-1200

Programme	Default Speed(rpm)		Programme	Default Speed(rpm)	
	1000	1200		1000	1200
Cotton Cold	800	1000	Spin only	800	1000
Cotton 20°C	800	1000	Hygiene 90°C	1000	1000
Cotton 40°C	800	1000	Mix 60°C	800	1000
Cotton 60°C	800	1000	Mix 40°C	800	1000
Jeans	800	1000	Mix 20°C	800	1000
Delicate	800	800	Rapid 45'	800	1000
ECO 40-60	1000	1200	Quick 15'	800	800
Rinse & Spin	800	1000			

⚠ Caution!

- When the lights of spin speed are off means the spin speed is 0.

OPERATIONS



Mute the buzzer



Start

Press the [Delay]&[Spin] button for 3sec.
the buzzer is mute.

To act the buzzer function, press the two buttons again for 3 seconds. The setting will be kept until the next reset.

⚠ Caution!

- After Muting the buzzer function, the sounds will not be activated any more.

OPERATIONS

■ Programmes

Programmes are available according to the laundry type.

Programmes	
Cotton	Hard-wearing textiles, heat-resistant textiles made of cotton or linen.
Hygiene 90°C	Washing machine can kill some bacterium, and achieve hygiene effect.
Rapid 45'	This programme is suitable for washing not very dirty clothes, save more energy and washing.
Mix	Mixed load consisting of textiles made of cotton and synthetics.
Jeans	Specially for jeans.
Quick 15'	Extra short programme approx, suitable for lightly soiled washing as a small amounts of laundry.
Spin Only	Extra spin with selectable spin speed.
Rinse&Spin	Extra rinse with spin.
ECO 40-60	Default 40°C, not selectable, suitable for laundry washing at about 40°C-60°C.
Delicate	For delicate, washable textiles, e.g. made of silk, satin, synthetic fibres or blended fabrics.

Note!

- Reference to your product to select the programmes.

OPERATIONS

■ Washing Programmes Table

Programme	Load(kg)	Default Time
	7.5	7.5 1200
Cotton Cold	7.5	2:10
Cotton 20°C	7.5	2:20
Cotton 40°C	7.5	2:40
Cotton 60°C	7.5	2:30
Jeans	7.5	1:48
Delicate	2.0	0:50
ECO 40-60	7.5	3:53
Rinse & Spin	7.5	0:20
Spin only	7.5	0:12
Hygiene 90°C	3.0	2:18
Mix 60°C	7.5	1:30
Mix 40°C	7.5	1:20
Mix 20°C	7.5	1:00
Rapid 45'	2.0	0:45
Quick 15'	2.0	0:15



Note!

- The parameters in this table are only for user's reference. The actual parameters maybe different with the parameters in above mentioned table.

MAINTENANCES

■ Cleaning And Care

Warning!

- Before your maintenance starts, please unplug the machine and close the tap.

Cleaning The Cabinet

Proper maintenance on the washing machine can extend its working life. The surface can be cleaned with diluted non-abrasive neutral detergents when necessary. If there is any water overflow, use the wet cloth to wipe it off immediately. No sharp items are allowed.



Note!

- Formic acid and its diluted solvents or equivalent are forbidden, such as alcohol, solvents or chemical products, etc.

Cleaning The Drum

The rusts left inside the drum by the metal articles shall be removed immediately with chlorine-free detergents. Never use steel wool.

Note!

- Don't put laundry in the washing machine during the drum cleaning.

Cleaning The Door Seal And Glass

Wipe the glass and seal after each wash to remove lint and stains. If lint builds up it can cause leaks. Remove any coins, buttons and other objects from the seal after each wash.

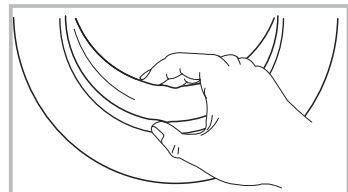

MAINTENANCES

Cleaning The Inlet Filter

Note!

- Inlet filter must be cleaned if there is less water.

Washing the filter in the tap

1. Close the tap.
2. Remove the water supply hose from the tap.
3. Clean the filter.
4. Reconnect the water supply hose.

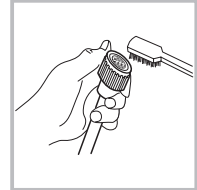
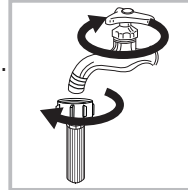

Washing the filter in washing machine:

1. Screw off the inlet pipe from the backside of the machine.
2. Pull out the filter with long nose pliers and reinstall it back after being washed.
3. Use the brush to clean the filter.
4. Reconnect the inlet pipe.

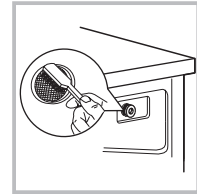
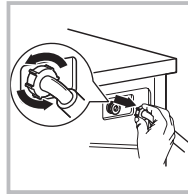

Note!

- If the brush is not clean, you can pull out the filter washed separately;
- Reconnect, turn on the tap.

Clean The Detergent Dispenser

1. Press down the arrow location on softener cover inside the dispenser drawer.
2. Lift the clip up and take out softener cover and wash all grooves with water.
3. Restore the softener cover and push the drawer into position.

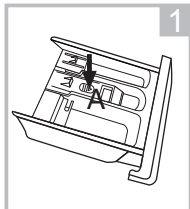

Pull out the dispenser drawer with press the A

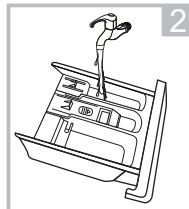

Clean the dispenser drawer under water

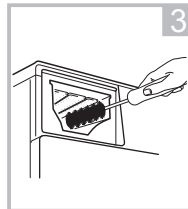

Clean inside the recess with an old toothbrush

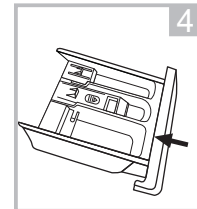

Insert the dispenser drawer

Note!

- Do not use alcohol, solvents or chemical products to clean the machine.

MAINTENANCES

Cleaning The Drain Pump Filter

⚠ Warning!

- Be careful of the hot water!
- Allow detergent solution to cool down.
- Unplug the machine to avoid electrical shock before washing.
- Drain pump filter can filter the yarns and small foreign matters from the washing.
- Clean the filter periodically to ensure the normal operation of washing machine.

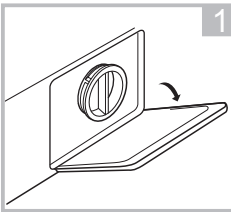

Open the lower cover cap

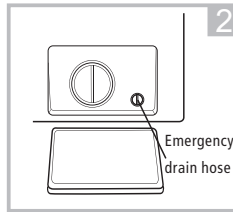

Rotate 90°C and pull out the emergency drain hose, and take off the hose cap

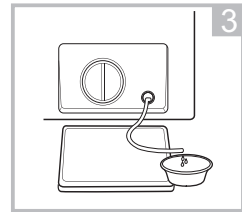

After water runs out, reset the drain hose

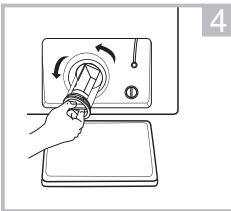

Open the filter by turning to the counter clockwise

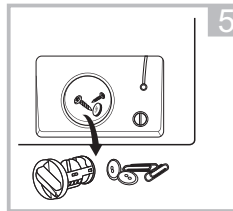

Remove extraneous matter

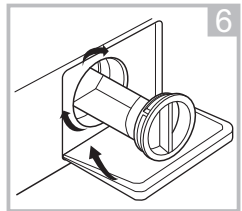

Close the lower cover cap

⚠ Caution!

- Make sure that valve cap and emergency drain hose are reinstalled properly, cap plates should be inserted aligning to hole plates otherwise water may leak.
- Some machines don't have emergency drain hose, so step 2 and step 3 can be skipped. Rotate lower cover cap directly to make water run into basin.
- When the appliance is in use and depending on the programme selected there can be hot water in the pump. Never remove the pump cover during a wash cycle, always wait until the appliance has finished the cycle, and is empty. When replacing the cover, ensure it is securely re-tightened.

MAINTENANCES

■ Trouble Shooting

The start of the appliance does not work or it stops during operation.
First try to find a solution to the problem, If not, contact the service centre.

Description	Reason	Solution
Washing machine cannot start up	Door is not closed properly	Restart after the door is closed Check if the clothes is stuck
Door can't be opened	Washer's safety protection design is working	Disconnect the power, restart the product
Water leakage	The connection between inlet pipe or outlet hose is not tight	Check and fasten water pipes Clean up outlet hose
Detergent residues in the box	Detergent is dampened or agglomerated	Clean and wipe the detergent box
Indicator or display does not light	Disconnect the power PC board or harness has connection problem	Check if the power is shut down and the power plug is connected correctly
Abnormal noise		Check if the fixing (bolts) have been removed Check it's installed on a solid and level floor

Description	Reason	Solution
E30	Door is not closed properly	Restart after the door is closed Check if the clothes is stuck
E10	Water injecting problem while washing	Check if the water pressure is too low Straighten the water pipe Check if the inlet valve filter is blocked
E21	Overtime water draining	Check if the drain hose is blocked
E12	Water overflow	Restart the washer
EXX	Others	Please try again first, call up service line if there are still troubles

Note!

- After the check, activate the appliance. If the problem occurs or the display shows other alarm codes again, contact the service.

MAINTENANCES

■ Technical Specifications

Power Supply 220-240V~,50Hz

MAX.Current 10A

Standard Water Pressure 0.05MPa~1MPa

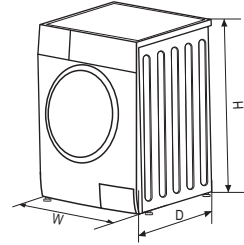

Model	Washing Capacity	Dimension (W*D*Hmm)	Net Weight	Rated Power
MF100W75	7.5kg	595*400*850	55kg	2050W



QUESTIONS OR COMMENTS

Country	Contact Center	Web Site
Thailand	+6621077799	http://www.midea.com/th
Myanmar	+09260367229	https://www.gbs.com.mm/en/about/vsk/
Cambodia	+85523212435	http://bluemidea.com
Vietnam	+1800588863	http://vn.midea.com
Philippines	+63288635522	http://www.mideaph.com
Indonesian	+628001888523	http://id.midea.com
Malaysia	+60392211033	https://www.midea.com/my/
Singapore	+62222536	https://www.midea.com/sg/

This product is RoHS compliant.



make yourself at home