



Cordless Floor Cleaner

USER MANUAL

MVC-X10

All the contents of this Guide have been checked carefully. If there are any printing errors OR misunderstanding, please contact with Midea Customer service team.

NOTE: It will be compiled into the new version of the guide without any notice if involve the technical improvements.

Thank you for choosing Midea! Please read this user manual be carefully before start use this new appliance. To ensure that you know the operate knowledge and understand more about the product features and functions in a safe way.

CONTENTS

INDEX	01
SAFETY INSTRUCTIONS	02
SPECIFICATIONS	06
PRODUCT INTRODUCTION	07
INSTALLATION	11
OPERATING INSTRUCTION	13
CLEANING AND MAINTENANCE	15
TROUBLESHOOTING	19
TRADEMARKS, COPYRIGHTS AND LEGAL STATEMENT	21

SAFETY INSTRUCTIONS

Intended Use

The following safety guidelines are intended to prevent unforeseen risks or damage from unsafe or incorrect operation of the appliance. Please check the packaging and appliance on arrival to make sure everything is intact to ensure safe operation. If you find any damage, please contact the retailer or dealer. Please note modifications or alterations to the appliance are not allowed for your safety concern. Unintended use may cause hazards and loss of warranty claims.

Explanation of Symbols



Danger

This symbol indicates that there are dangers to the life and health of persons due to extremely flammable gas.



Warning of electrical voltage

This symbol indicates that there is a danger to life and health of persons due to voltage.



Warning

The signal word indicates a hazard with a medium level of risk which, if not avoided, may result in death or serious injury.



Caution

The signal word indicates a hazard with a low degree of risk which, if not avoided, may result in minor or moderate injury.



Attention

The signal word indicates important information (e.g. damage to property), but not danger.



Observe instructions

This symbol indicates that a service technician should only operate and maintain this appliance in accordance with the operating instructions.

Read these operating instructions carefully and attentively before using/commissioning the unit and keep them in the immediate vicinity of the installation site or unit for later use!

Safety Instructions

- This product is suitable for hard floors in the indoor environment, including waxed floors, stone floors, rubber floors, marble floors, granite floors, terrazzo floors, solid wood floors, composite floors, bamboo floors, as well as glazed tiles, ceramic facing tiles and other flat ground. It may not achieve the best results if the product is used on uneven ground surface.
- Do not use this product near or on the surface of flammable and explosive objects, which may cause fire and explosion.
- Do not use this product near a working fireplace or heater to prevent deformation of the machine casing.
- Do not use it to clean high-temperature substances (unextinguished cigarette butts, matches or hot ash, etc.), ultra-fine substances (such as lime, cement, wood chips, gypsum powder, ashes, charcoal, etc.), dangerous substances (such as solvents, descaling agents, etc.), chemical substances (such as acidic substances, detergents, etc.) and other substances with uncertain physical properties.
- Do not use this floor cleaner to absorb detergent, kerosene, gasoline, alcohol, paint or perfume, or else it may cause short-circuit, fire or explosion.
- Do not use this floor cleaner to absorb toner used in laser printers and copiers, or else it may cause fire or explosion.
- Do not use this floor cleaner to absorb sharp or large objects, such as glass shards, small toys, pins, paper clips, stones, plaster and large pieces of paper, or else it may block up and damage the machine.
- Do not use this floor cleaner to absorb any burning or smoking objects, such as soot from the unextinguished heat source, burning cigarette butts or matches.
- This product can't be used to clean stains of strong grease, strong viscosity, or strong dyeing properties such as shoe polish, paint, and pigments.
- Do not touch the plug or any live part of the product with wet hands to avoid the risk of electric shock.
- Stop using it if the plug is damaged. Please call our service personnel for replacement in order to avoid hazards.
- Please keep the airflow channels and moving parts of this product away from long hair, loose clothing, fingers and other parts of the body. Do not point the suction tube, accessory tip or tool to the eyes or ears, or put them in the mouth.
- Please use the cleaning agent produced by our company and the manufacturer approved by us.
- Do not add other solutions to avoid generating toxic and harmful gases. If electric leakage, motor over-temperature, abnormal noise, peculiar smell or weak suction is found during use, stop using it immediately and call our service personnel.
- After using the machine, please clean the wastewater tank in time to avoid peculiar smell, and keep the ventilation path unobstructed, so as to avoid obstruction, or else it will cause the suction power to drop, the motor to heat up, and will affect the service life of the floor cleaner.
- After using the machine, please store it in a dry place. A humid place will affect the insulation and service life of the appliance.
- Do not soak or rinse the floor cleaner or floor brush in water.

Safety Instructions

- This appliance can be used by children aged from 8 years and above and persons with reduced physical, sensory or mental capabilities or lack of experience and knowledge if they have been given supervision or instruction concerning use of the appliance in a safe way and understand the hazards involved.
- Cleaning and user maintenance shall not be made by children without supervision.
- Children should not play with the appliance.
- Please check the suction nozzle regularly. If there is a blockage, please clear it in time to avoid decrease in suction and affecting the performance of the machine.
Turn off the power before replacing the brush.
- In the following situations, do not use the machine, contact to our customer service center for inspection and repair in time:
 1. Obvious damage or abnormal operation caused by drop;
 2. Power cord is damaged.
- Do not disassemble the enclosed machine without permission. There are no user serviceable parts. Do not try to change the performance of the machine, or else it will cause danger.
- Using a voltage that does not match the specifications will cause damage to the product and more likely to cause harm to the user. The correct rated voltage is marked on the nameplate.
- When cleaning the stairs, be extra cautious to prevent falling.
- Do not shake or impact the machine up and down to prevent wastewater from flowing into the motor.
- When the motor is working, do not lift or carry the appliance up and down, and do not put the machine on its side to prevent the wastewater from entering the motor.
- To prevent tip-over, place the machine against the wall after use.
- Do not use the floor cleaner before the clean water tank and wastewater tank are installed properly.
- Do not place any small objects in the outlet or block the outlet. Remove any small objects that may interfere with the flow of air through the outlet to prevent overheating of the machine.
- Do not wet the machine body, or it may cause damage and fire due to short circuit.
- This is only allow to use the docking station for charge the battery.
- The plug must be removed from the socket-outlet before cleaning or maintaining the appliance.
- All the technologies and other data in this manual are obtained by our company or the designated third party testing company, and we reserve the right of final interpretation.

Use and Precautions of Washer Detergent

- Mix and clean according to instructions. It is recommended to use cleaning liquid produced by our company or manufacturers approved by our company, which do not contain acid, alkali solutions or substances harmful to the environment.
- If a large amount of cleaning liquid is added, more foam will be generated when used, which may infiltrate into the motor and cause danger.
- The cleaning liquid should be kept out of reach of children. If the cleaning liquid accidentally gets into eyes, rinse thoroughly with clean water; in case of accidental ingestion, seek medical treatment immediately. Follow local environmental protection regulations when handling wastewater and cleaning liquid.

**READ CAREFULLY AND KEEP FOR FUTURE
REFERENCE**

SPECIFICATIONS

Product Model	MVC-X10
Charging rated input	220-240V- 50Hz 150W
Charging output	25V \equiv 1A
Power	220W
Voltage	22.2V \equiv
Net Weight	6.83kg
Product Size	270x235x1160mm

Product Introduction

Product introduction

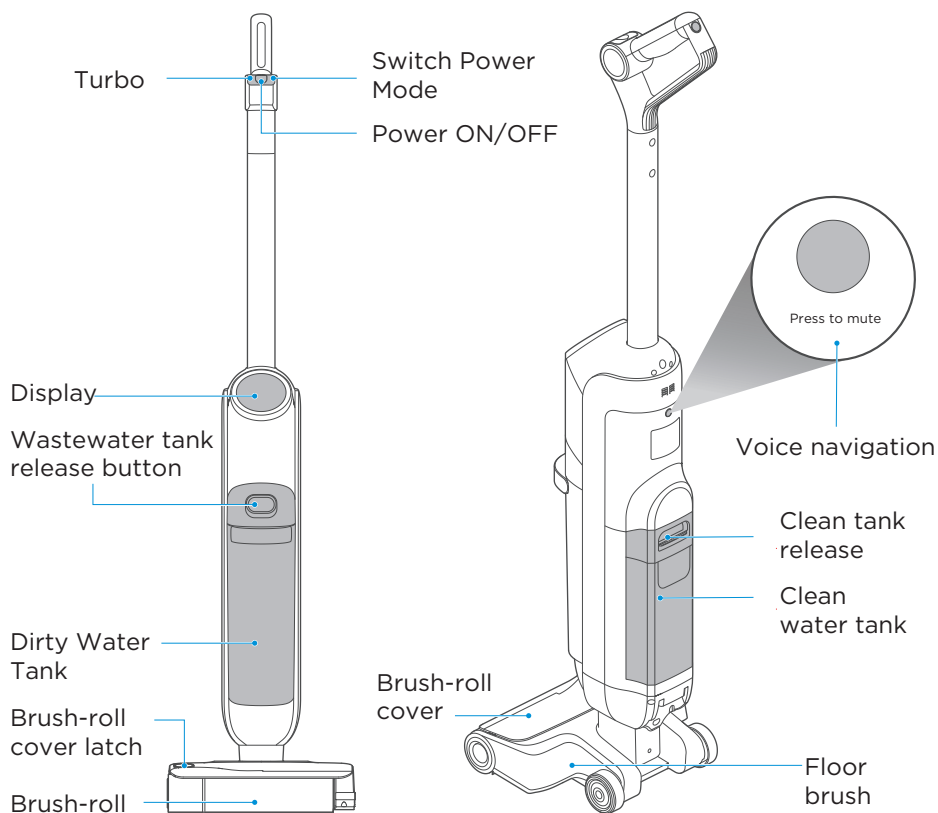

List of Accessories



Docking station



Accessory holder

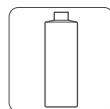

Floor Washer Detergent

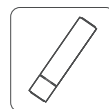

Brush-roll

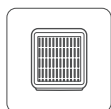

Filter



Cleaning brush

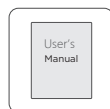

User's Manual

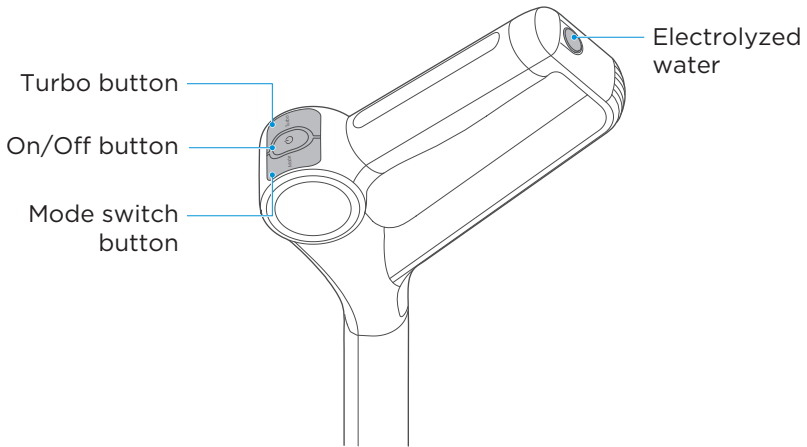

1. Mode switch button

- Auto mode: the water from the machine wets the brush-roll to clean the floor;



- Quick suction mode: the machine stops discharging water, and sucks dry garbage or residual water;



2. Turbo button

- Turbo mode: the speed of the brush-roll and the amount of water are increased to forcefully remove the heavy stains on the floor;

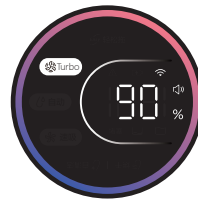

3. Electrolyzed Water

- Cleaning and disinfecting agent obtained by means of electrolysis with a dilute sodium chloride solution and it is no harm to the human body and friendly to the environment.



Docking Station

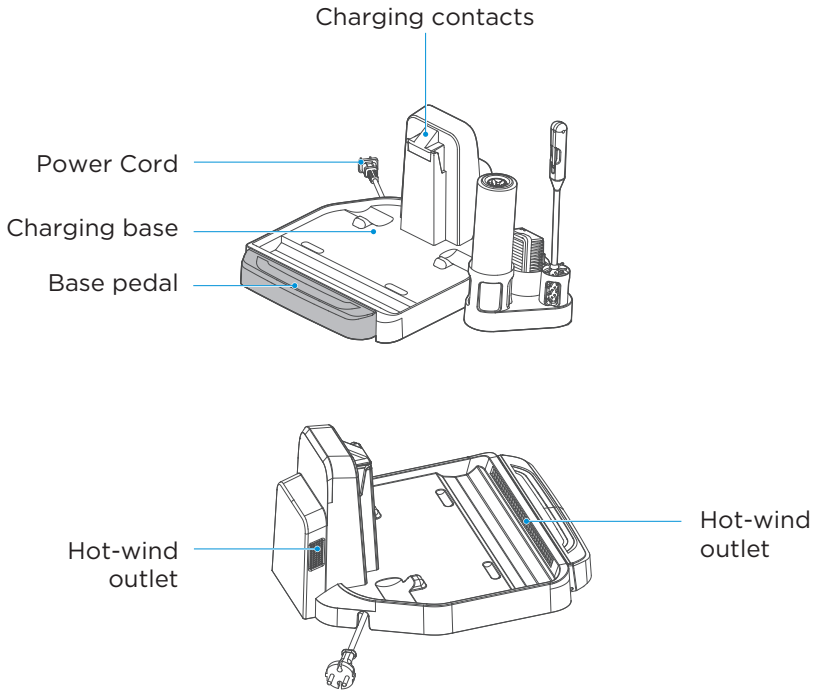

- After use, put the machine into the charging base for charging, self-cleaning and drying.

Cleaning brush

- One end is a brush to clean the stubborn dirt attached to the wastewater tank and the pipe under the ventilation pipe;

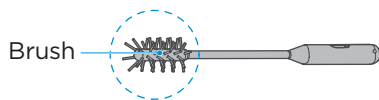

- The other end is a rotating blade to clean the hair wrapped on the roller brush.

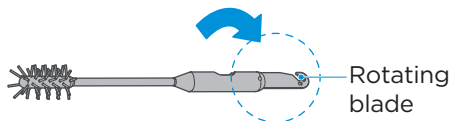

Accessory holder

- Insert the protruding part of the accessory holder into the groove of the air drying base;
- It is used to store roller brush, cleaning brush and filter.

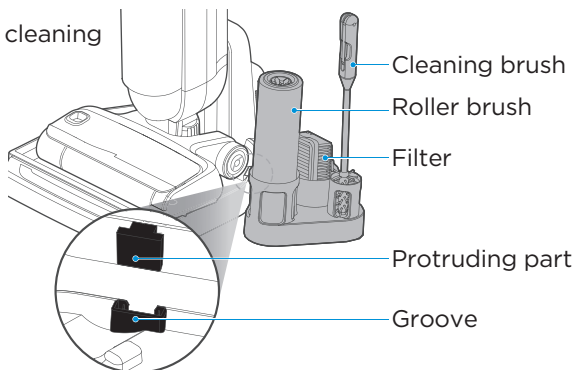

Cleaning liquid

- Pay attention to the proportion of cleaning liquid added;
- Use the cleaning liquid that comes with the product.

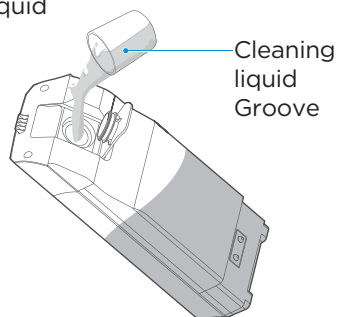

Installation

Handle Installation and Removal

Installation

Insert the end of the handle into the port of the main unit along the vertical direction until there is a click, which indicates the installation is successful;

Removal

Remove the rubber from the hole in the back, insert a screwdriver or other tools into the hole, and pull out the handle upward.

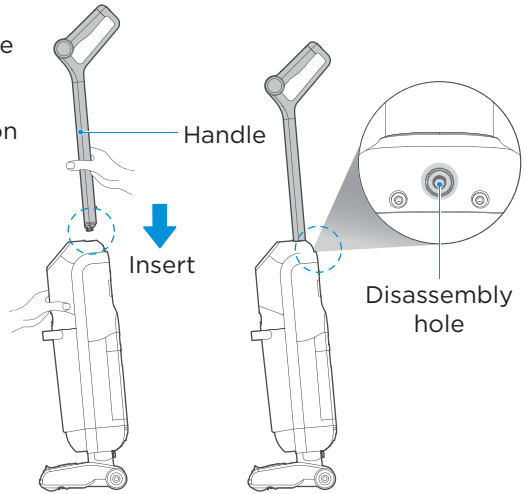

Charging Battery



Attention

Charge the product before the first use.

1. Connect the power plug to 220-240V- power supply;
2. Put the machine upright into the charging base, and make sure that the bottom of the body completely falls into the charging base. At this moment, a voice will prompt “start charging”, and the screen will display the charging quantity.
3. It takes about 4 hours to fully charge the machine. When the battery is fully charged, the screen will go out and the machine will automatically power off.

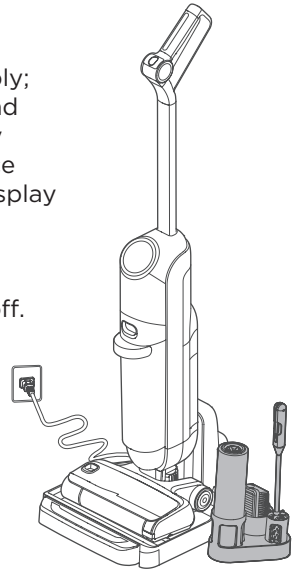

Filling clean water tank



Attention

Fill water only to the clean water tank.

1. Press the clean water tank button with the thumb and pull outward to remove the clean water tank;
2. Open the top cover of the clean water tank and fill tap water to the tank;

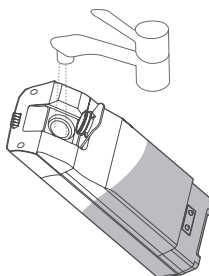
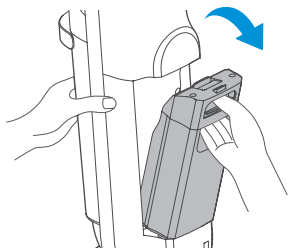

3. If deep cleaning is required, pour cleaning liquid into the tank according to the instructions on the bottle;
4. Tighten the cover of the clean water tank;

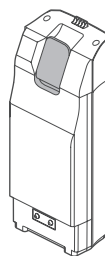
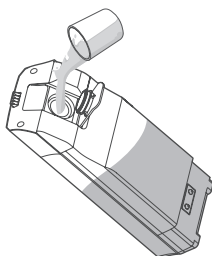

5. Install the clean water tank back to the body as it is, and the installation is successful when you hear a click;
6. When the clean water tank is short of water, there will be voice prompt; in this case, no water is sprayed in auto mode, but the quick mode can be used normally.

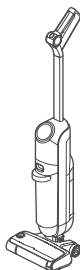
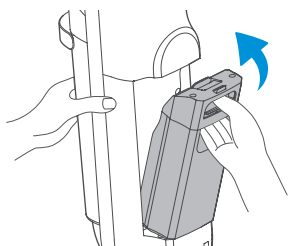

 Please add water to clean water tank

Operating Instruction

Turning on and Cleaning

1. Step on the floor brush and pull the handle, and the machine enters standby state.

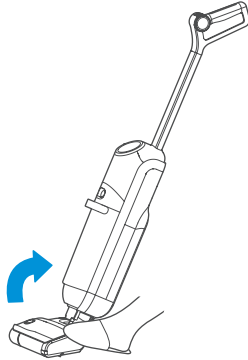

2. Press the On/Off button to turn on/off the machine.

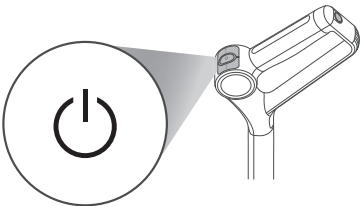

3. It enters auto mode after turning on; you can press the Mode button to switch to quick suction mode.

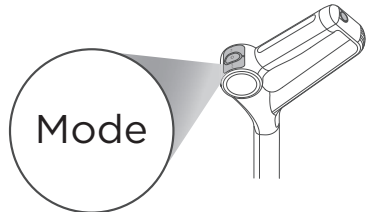

4. Press the Turbo button to enable or disable this function.

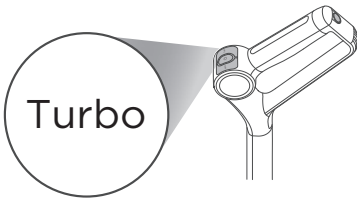

5. Anti-bacteria function
This function can only be turned on in auto or turbo mode.

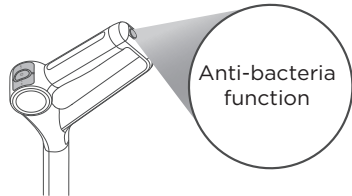

Attention

After using the machine, it is recommended to place it vertically on the specially designed charging base.

Upright Pause Function

In working state, you can step on the floor brush to erect the body, the machine will stop working and enter standby state; it will automatically turn off after 3 minutes of standby.

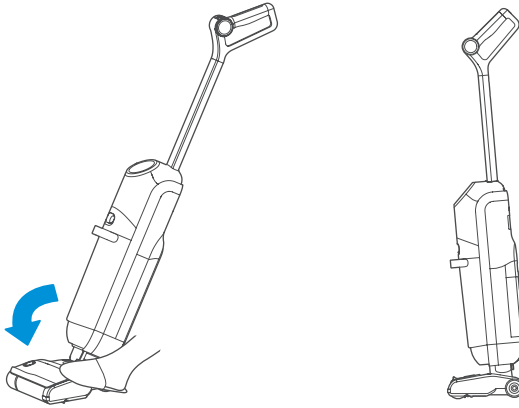

Self-cleaning + Drying Function

Put the machine into the charging base, ensure that it is in the charging state, step on the pedal of the charging base with your foot, and start self-cleaning; during the process, if you need to stop the self-cleaning/drying function, step on the pedal for 3 seconds or press the On/Off button; after self-cleaning, clean the wastewater tank in time; if there are residual stains on the base, clean it in time.

Self-cleaning: the machine automatically cleans the roller brush and body pipe (about 2 minutes);

Drying: Keep blowing warm air on the charging base, and dry the roller brush properly (about 50 minutes);

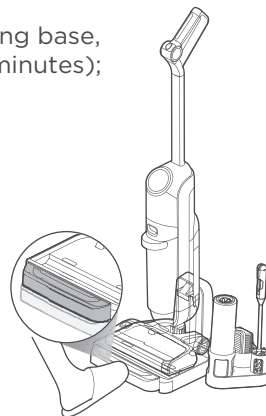

Cleaning and Maintenance

Waste water detect alarm



Attention

1. After cleaning, it is recommended to place the machine upright in the charging base; do not place the machine in places with direct sunlight or moisture;
2. In order not to affect the performance of the machine, it is recommended that you regularly maintain its parts;
3. Before cleaning, please disconnect the power supply to stop the machine;
4. Scrub with water or neutral detergent, wring out the cleaning cloth before scrubbing to avoid water leaking into the electrical components.

1. Press the button of wastewater tank with your thumb and pull outward to remove the tank.

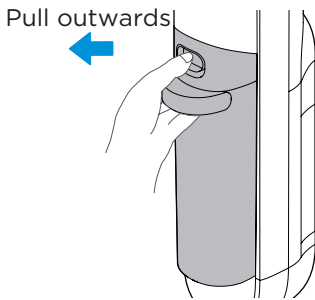

2. Hold the tank with one hand and pull out the top cover of the tank with the other hand.

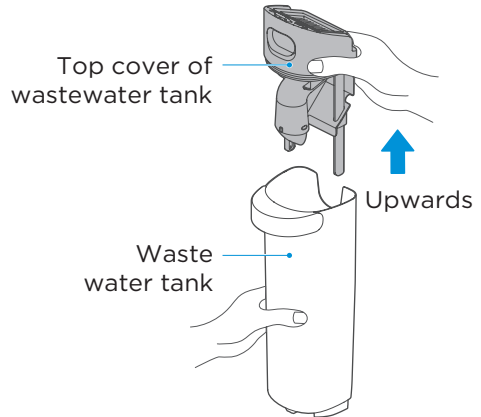

3. As shown in the figure, pour out the wastewater from the side of the tank. If there is stubborn dirt on the inner wall of the tank, please clean it directly with a cleaning brush.

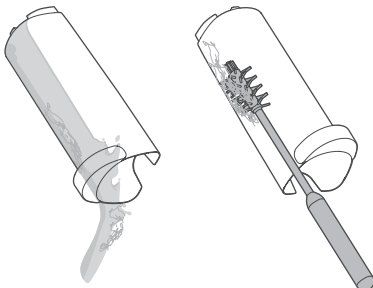

4. Take out the filter from the top cover of the wastewater tank and check whether there is any foreign matter stuck on the cover.

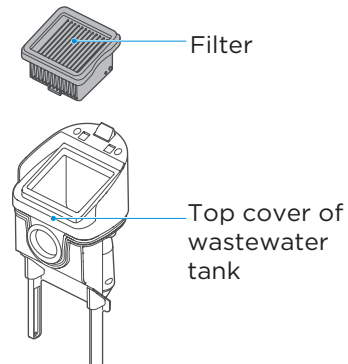

5. Wash with clean water after taking it out, dry it thoroughly and put it back as it was.

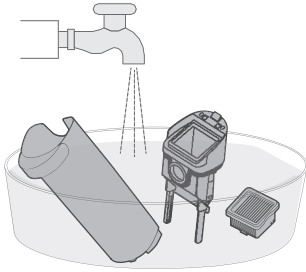

Wash

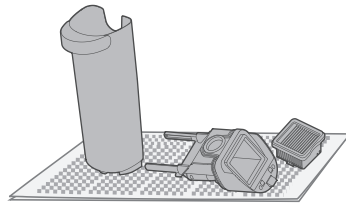

Dry

6. Press the following elastic buckles on both sides to remove the air duct and rinse it with water; install as it was after rinsing.

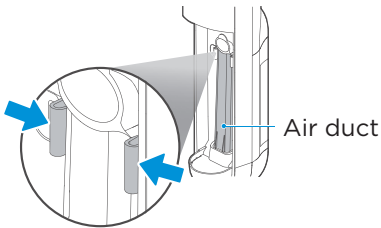

Press to remove

7. Install the wastewater tank back to the machine until there is a click sound; (when installing wastewater tank, it is recommended to hold the body with another hand to avoid tipping over).

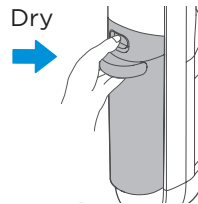

Brush-roll and Cover cleaning



Attention

1. It is recommended that after each use, the roller brush and cover should be cleaned and dried in time;
2. If residual stains are found on the suction surface of the floor brush, wipe it with a wet cloth. Do not rinse it with water.

1. Press the latch as shown, and remove the cover and the roller brush;

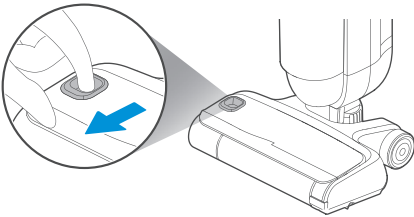

2. Remove the cover and the roller brush, open the rotating blade of the cleaning brush, and remove the hair and other entanglements on the roller brush;

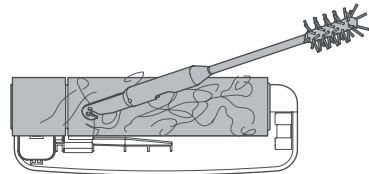

3. Remove the small roller brush and large roller brush in the direction shown in the figure and rinse the roller brushes and cover with clean water;

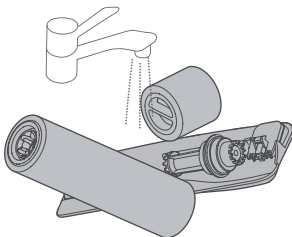
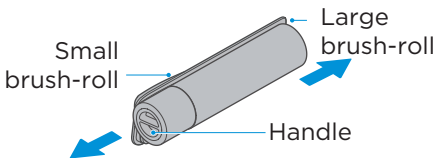

4. After cleaning, install the small and large roller brushes in turn according to the direction shown in the figure. The installation is successful when you hear a click sound.

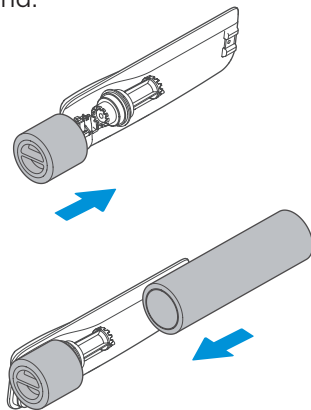

5. If residual stains are found in the suction port of the floor brush (exposed part after the roller brush is removed), wipe it; do not rinse with water;

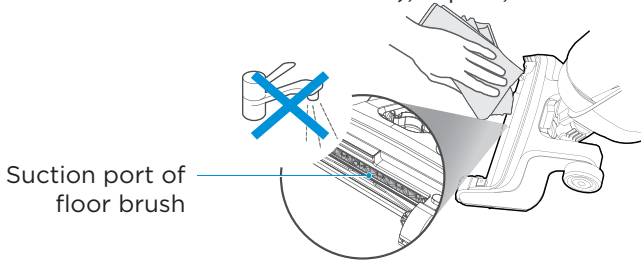

6. After cleaning, align the cover of the roller brush with one end of the driven wheel of the floor brush motor, and then align the latch of the cover of the roller brush with the latch slot of the cover of the roller brush. The installation is successful when you hear a click sound.

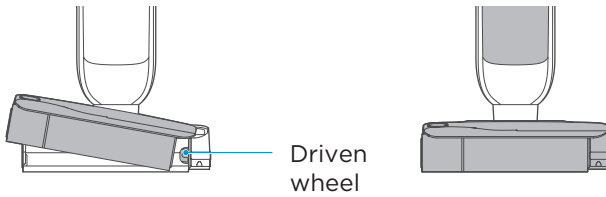

Troubleshooting

Please check the following table in case of any abnormal conditions when using the product.

Problem	Possible cause	Solution
The floor cleaner does not work	<ul style="list-style-type: none"> The roller brush is entangled by hair or stuck by foreign objects 	Remove the roller brush to clean and reinstall
	<ul style="list-style-type: none"> Wastewater tank is full 	Clean the wastewater tank
	<ul style="list-style-type: none"> Water shortage in clean water tank 	Add water to clean water tank
	<ul style="list-style-type: none"> There is garbage blockage in the pipe 	Clean the pipes under the wastewater tank
	<ul style="list-style-type: none"> Low battery voltage 	Charge
Suction power is weakened	<ul style="list-style-type: none"> Roller brush, roller brush cover, or wastewater tank is not installed in place 	Remove all components and reinstall them
	<ul style="list-style-type: none"> Roller brush is entangled by hair 	Clean the roller brush
	<ul style="list-style-type: none"> There is hair accumulation on the roller shaft 	Remove the roller brush to clean the shaft
	<ul style="list-style-type: none"> Floor brush suction or pipe blockage 	Wipe the floor brush suction and clean the pipe under the air duct
	<ul style="list-style-type: none"> Wastewater tank filter is dirty 	Clean the filter and dry thoroughly before installation
	<ul style="list-style-type: none"> Wastewater tank filter isn't installed 	Install filter
Noise when the fan is running	<ul style="list-style-type: none"> Foreign matter in the suction port of the floor brush or in the pipe 	Wipe the suction port and clean the pipe under the air duct
	<ul style="list-style-type: none"> Wastewater tank is full 	Clean the Wastewater tank
	<ul style="list-style-type: none"> Air duct isn't installed 	Install air duct

Problem	Possible cause	Solution
Floor brush doesn't spray water	<ul style="list-style-type: none"> • Water shortage in clean water tank 	Add water to the clean water tank
	<ul style="list-style-type: none"> • Clean water tank is not installed properly 	Reinstall the clean water tank
Air outlet leaks water	<ul style="list-style-type: none"> • Too much water in the wastewater tank 	Clean the wastewater tank
	<ul style="list-style-type: none"> • Wastewater tank filter isn't installed 	Install filter
	<ul style="list-style-type: none"> • Wastewater tank filter is cleaned and not dried after use 	Clean the filter and dry thoroughly before installation
Water leakage at the bottom of floor brush	<ul style="list-style-type: none"> • Wastewater tank or filter isn't installed 	Install wastewater tank and filter

TRADEMARKS, COPYRIGHTS AND LEGAL STATEMENT

 Midea logo, word marks, trade name, trade dress and all versions thereof are valuable assets of Midea Group and/or its affiliates (“Midea”), to which Midea owns trademarks, copyrights and other intellectual property rights, and all goodwill derived from using any part of an Midea trademark. Use of Midea trademark for commercial purposes without the prior written consent of Midea may constitute trademark infringement or unfair competition in violation of relevant laws.

This manual is created by Midea and Midea reserves all copyrights thereof. No entity or individual may use, duplicate, modify, distribute in whole or in part this manual, or bundle or sell with other products without the prior written consent of Midea.

All the described functions and instructions were up to date at the time of printing this manual. However, the actual product may vary due to improved functions and designs.



make yourself at home



www.midea.com

© Midea 2022 all rights reserved